

**Technical training.
Product information.**

5 Series LCI



BMW Service

Edited for the U.S. market by:
**BMW Group University
Technical Training**

ST1309

8/1/2013

General information

Symbols used

The following symbol is used in this document to facilitate better comprehension or to draw attention to very important information:



Contains important safety information and information that needs to be observed strictly in order to guarantee the smooth operation of the system.

Information status and national-market versions

BMW Group vehicles meet the requirements of the highest safety and quality standards. Changes in requirements for environmental protection, customer benefits and design render necessary continuous development of systems and components. Consequently, there may be discrepancies between the contents of this document and the vehicles available in the training course.

This document basically relates to the European version of left-hand drive vehicles. Some operating elements or components are arranged differently in right-hand drive vehicles than shown in the graphics in this document. Further differences may arise as the result of the equipment specification in specific markets or countries.

Additional sources of information

Further information on the individual topics can be found in the following:

- Owner's Handbook
- Integrated Service Technical Application.

Contact: conceptinfo@bmw.de

©2013 BMW AG, Munich

Reprints of this publication or its parts require the written approval of BMW AG, Munich

The information contained in this document forms an integral part of the technical training of the BMW Group and is intended for the trainer and participants in the seminar. Refer to the latest relevant information systems of the BMW Group for any changes/additions to the technical data.

Information status: **April 2013**
BV-72/Technical Training

5 Series LCI

Contents.

1.	Introduction	1
1.1.	Models.....	1
1.1.1.	Gasoline engines.....	1
1.1.2.	Diesel engines.....	1
1.2.	Further information.....	1
2.	Body	2
2.1.	Acoustic measures.....	2
2.2.	Design changes.....	3
2.2.1.	Identification of all-wheel drive vehicles.....	5
2.3.	Exterior mirrors.....	6
2.3.1.	System wiring diagram.....	7
2.4.	Line package content.....	10
2.5.	Luggage compartment.....	11
3.	Powertrain	12
3.1.	Overview of engines.....	12
3.2.	N57TU engine.....	13
3.3.	N63TU engine.....	14
3.3.1.	Measures for CO2 reduction.....	14
3.4.	Automatic engine start/stop function.....	16
3.4.1.	Longitudinal jolt.....	16
3.4.2.	Stop delay.....	17
3.4.3.	Start strategy.....	18
3.4.4.	Starter motor.....	19
3.5.	CO2 measures.....	20
3.6.	Automatic transmission.....	20
3.6.1.	Sports automatic transmission.....	20
3.6.2.	ConnectedShift.....	20
3.6.3.	Coasting in idle.....	22
4.	Chassis and Suspension	23
4.1.	Electromechanical parking brake.....	23
5.	General Vehicle Electronics	24
5.1.	Voltage supply.....	24
5.1.1.	Deletion of DC/DC converter.....	24
5.1.2.	Battery.....	24
5.2.	Bus systems.....	25
5.2.1.	Bus overview.....	25
5.2.2.	MOST.....	28

5 Series LCI

Contents.

5.3.	Exterior lights.....	28
5.3.1.	Bi-xenon headlights.....	28
5.3.2.	Bi-xenon headlight with Adaptive Headlight.....	29
5.3.3.	Adaptive LED headlight.....	29
5.3.4.	Fog light.....	34
5.3.5.	Rear exterior lights.....	34
5.4.	Ambiance lighting.....	35
5.5.	Contactless tailgate activation.....	36
6.	Driver Assistance Systems.....	37
6.1.	Overview of optional equipment.....	37
6.2.	Overview of sensors.....	38
6.3.	BMW Night Vision.....	38
6.3.1.	BMW Night Vision with pedestrian and animal recognition.....	39
6.4.	Lane departure warning.....	43
6.4.1.	Functional limitations.....	44
6.5.	Camera-based collision warning (option 5AS).....	44
6.5.1.	Functional principle.....	45
6.5.2.	Operation.....	47
6.5.3.	Warning and braking function.....	48
6.5.4.	Timescale of collision warning with city braking function.....	51
6.5.5.	System limits.....	52
6.5.6.	Functional limitations.....	53
6.5.7.	Check Control messages.....	54
6.6.	Collision warning with braking function (option 5AT).....	55
6.6.1.	Functional principle.....	56
6.6.2.	Operation.....	56
6.6.3.	Warning and braking function.....	57
6.6.4.	History.....	61
6.6.5.	Comparison to the camera-based collision warning.....	62
6.7.	Speed Limit Info	62
6.7.1.	System limits.....	63
6.8.	High-beam assistant.....	65
6.9.	ACC Stop & Go.....	65
6.9.1.	Introduction.....	66
6.9.2.	System components.....	69
7.	Entertainment and Communication.....	73
7.1.	Headunits.....	73
7.1.1.	New features of Headunit High.....	73

5 Series LCI

Contents.

7.1.2.	Deletion of internal yaw sensor, Headunit High.....	77
7.2.	Speaker systems.....	77
7.3.	Rear seat entertainment system.....	77
7.4.	ConnectedDrive realignment.....	78
7.4.1.	BMW Assist eCall.....	79
7.4.2.	BMW TeleServices from 03/2013.....	81
7.4.3.	ConnectedDrive services	81
7.4.4.	Additional ConnectedDrive functions.....	82
7.4.5.	Internet	84
7.5.	BMW Apps.....	87
7.6.	Audio playback with Android.....	87
7.7.	Snap-in adapter.....	88
8.	Displays, Indicators and Controls.....	90
8.1.	ID transmitter.....	90
8.1.1.	Programming third and fourth button.....	90
8.1.2.	Changeover of symbol for fourth button.....	92
8.2.	Touchpad Controller.....	92
8.2.1.	Controller with touchpad	92
8.3.	Instrument cluster.....	95
8.4.	CID power display in SPORT mode	96
8.5.	Driver assistance system operating facility.....	97
8.6.	IHKA operating facility.....	98

5 Series LCI

1. Introduction

In July 2013 the model revision or the Life Cycle Impulse (LCI) of the BMW 5 Series enters the market.

For clearer representation, the revised BMW 5 Series is mentioned with the individual development series "BMW 5 Series LCI" or "F07 LCI", "F10 LCI" in this document.

1.1. Models

As before, the following body variants are offered:

- Sedan (F10 LCI)
- Gran Turismo (F07 LCI)

The model range of the BMW 5 Series LCI includes the following gasoline and diesel variants:

1.1.1. Gasoline engines

F07 LCI	F10 LCI
BMW 535i	BMW 528i
BMW 535i xDrive	BMW 528i xDrive
BMW 550i	BMW 535i
BMW 550i xDrive	BMW 535i xDrive
	BMW ActiveHybrid 5
	BMW 550i
	BMW 550i xDrive

1.1.2. Diesel engines

F10 LCI
BMW 535d
BMW 535d xDrive

1.2. Further information

Only the new features and adaptations of the BMW 5 Series LCI are described in this document.

For additional information on other components and systems, please refer to the appropriate documents for the vehicles and engines listed above.

5 Series LCI

2. Body

2.1. Acoustic measures

In the F10 LCI, the noise generation in the vehicle was reduced by various measures.

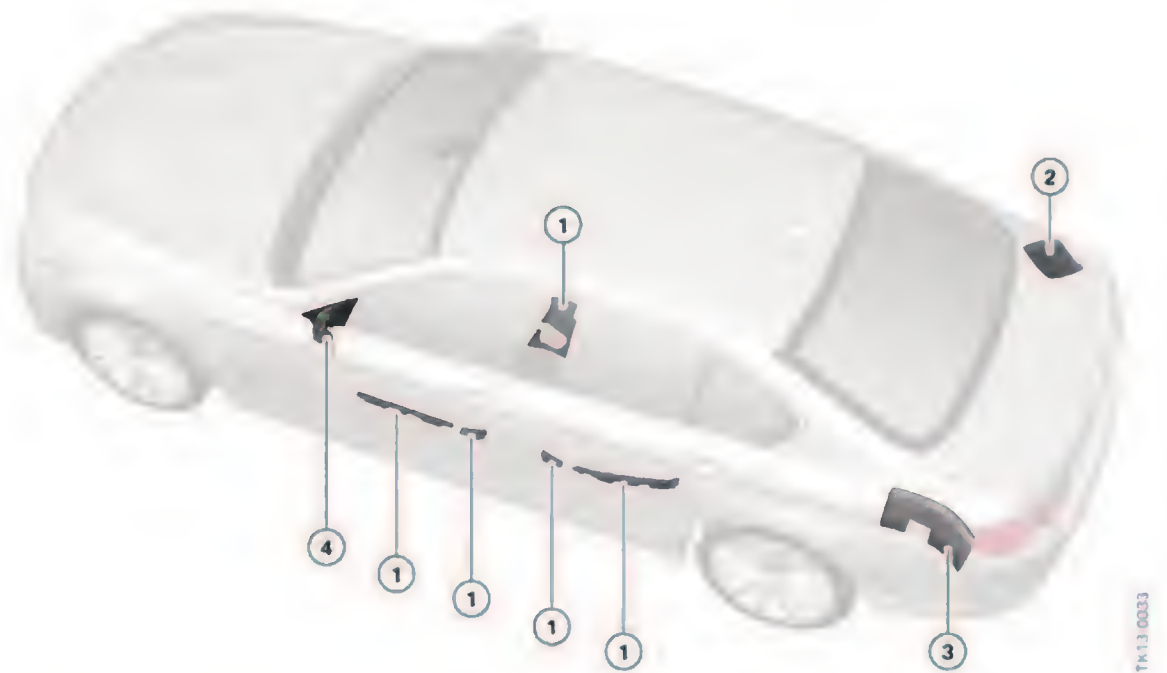

BMW F10 LCI measures for noise reduction

Index	Explanation
1	Foam part
2	Foam insert
3	Foam insert (F11 5 series Sport wagon, not for US)
4	Mirror base (new, with modified sealing of the mirror triangle)

5 Series LCI

2. Body

2.2. Design changes



BMW 5 Series LCI Design changes to front

The following design changes were made to the front of the BMW 5 Series LCI:

- New bumper panel
- New air inlet grille at bottom with different variants (with/without ACC, with/without fog light)
 - New design (horizontal rod look instead of diamond pattern)
 - New side gills with different variants for Basic, Luxury and Modern lines

5 Series LCI

2. Body



F07 design changes at rear

The following design changes were made to the rear of the F07 LCI:

- Tailgate with redesigned outer skin.
- New handle strip with integrated number plate lights, which were integrated in the tailgate without an additional cover/chrome strip.
- New plastic cover under the handle strip.
- Trim strip at the tailgate at the bottom for Luxury line (chrome surface) or Modern line (pearl shine, matt chrome surface).
- New rear lights.
- New bumper panel in three different versions depending on the exhaust system (the bumper support was also adapted based on the modified bumper panel).



F10 design changes at rear

5 Series LCI

2. Body

The following design changes were made to the rear of the F10 LCI and F18 LCI:

- New rear lights.
- New bumper panel in three different versions depending on the exhaust system.
- New, three-piece trim strip at the bumper (only for Luxury and Modern lines), which runs across the entire vehicle width and includes the rear reflectors at the side.

2.2.1. Identification of all-wheel drive vehicles



BMW 5 Series LCI xDrive identification

A redesigned xDrive model inscription is located at the rear of the vehicle to identify the all-wheel drive vehicles.

- **F07 LCI:** The xDrive model inscription is located at the rear on the bottom left
- **F10 LCI :** The xDrive model inscription is located at the rear on the top left

5 Series LCI

2. Body

2.3. Exterior mirrors



F10 LCI exterior mirror

As was first introduced with the F30, the side mounted turn signals are now integrated in the exterior mirrors in the BMW 5 Series LCI. The side turn signals in the front fenders are no longer used. An exception here is the BMW M5, in which the side turn signals are still installed in the fenders.

In addition, the power of the mirror heating is now reduced in ECO PRO mode depending on the temperature. However, it is not possible to completely switch off the mirror heating at low ambient temperatures.

5 Series LCI

2. Body

2.3.1. System wiring diagram

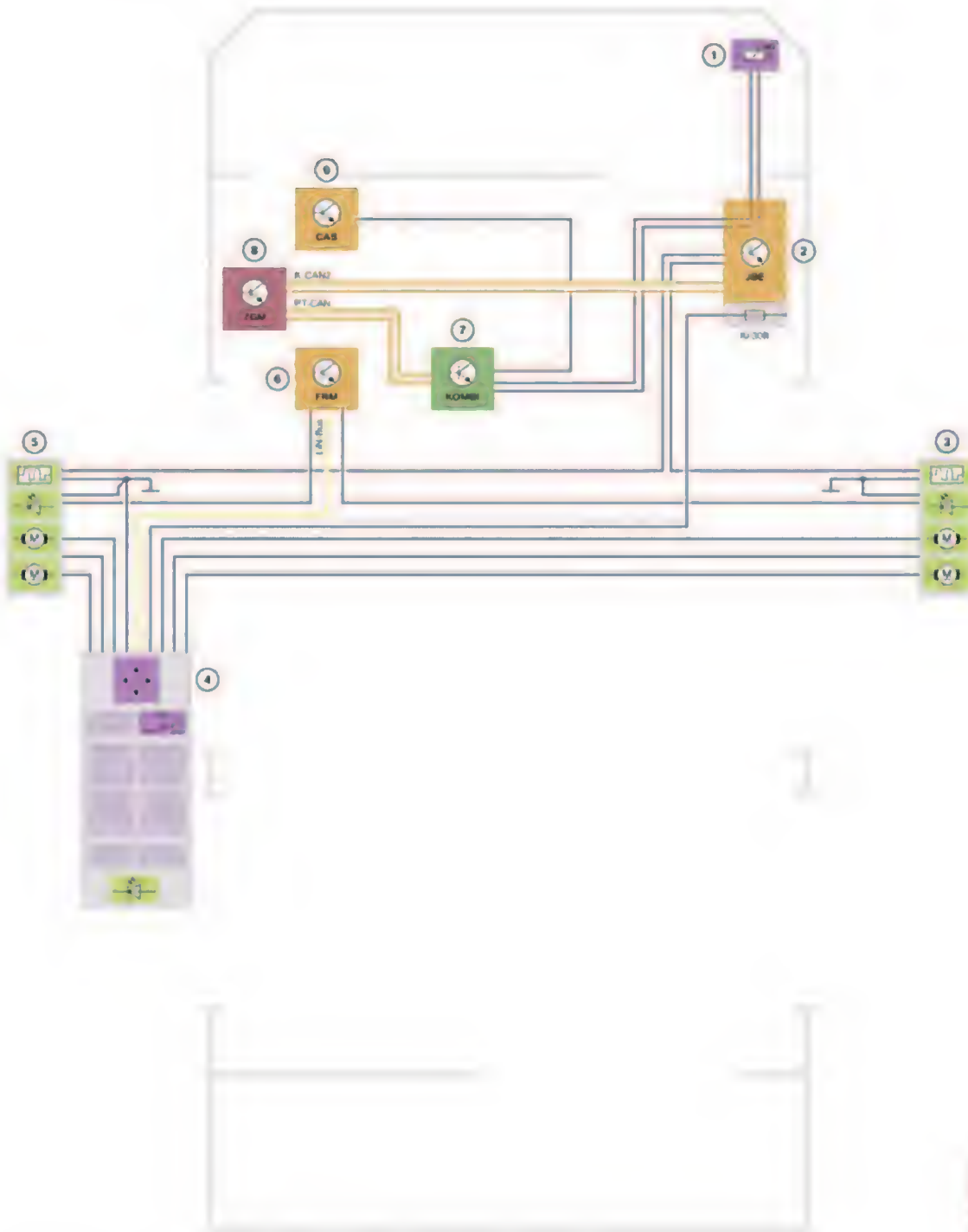

BMW 5 Series LCI System wiring diagram, exterior mirror

5 Series LCI

2. Body

Index	Explanation
1	Outside temperature sensor
2	Junction box electronics (JBE) with front power distribution box
3	Right exterior mirror
4	Switch block, driver's door
5	Left exterior mirror
6	Footwell module (FRM)
7	Instrument panel (KOMBI)
8	Central gateway module (ZGM)
9	Car access system (CAS)

5 Series LCI

2. Body

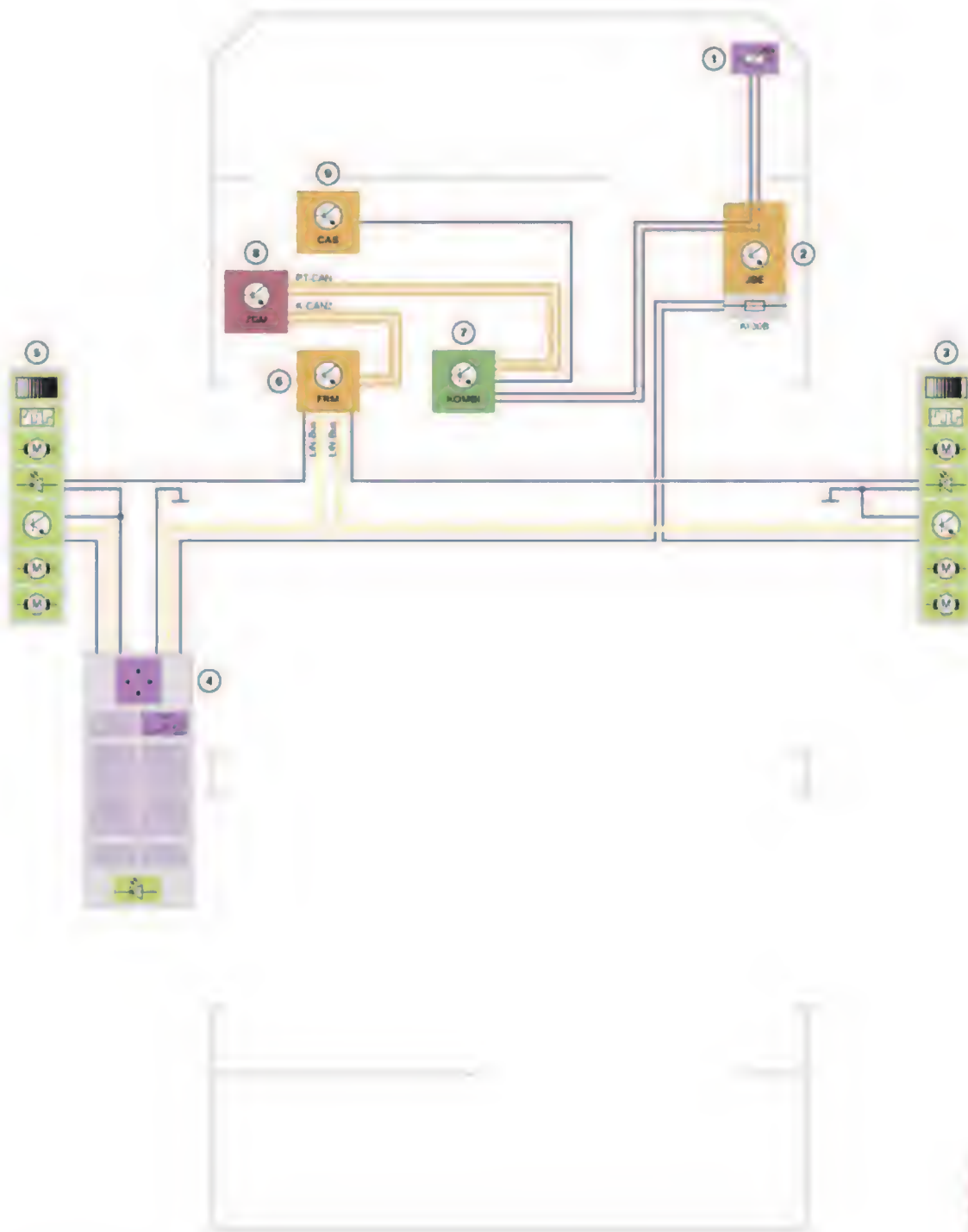

BMW 5 Series LCI System wiring diagram, electrochromic outside mirror (optional equipment)

TE 1 003B

5 Series LCI

2. Body

Index	Explanation
1	Outside temperature sensor
2	Junction box electronics (JBE) with front power distribution box
3	Right electrochromic outside mirror
4	Switch block, driver's door
5	Left electrochromic outside mirror
6	Footwell module (FRM)
7	Instrument panel (KOMBI)
8	Central gateway module (ZGM)
9	Car access system (CAS)

2.4. Line package content

Modern Line (ZML)	Luxury line (ZLL)
LED fog light	LED fog light
Elements of the ornamental grille, the air inlets, the rear bumper, the tailgate and the exhaust tailpipe in aluminium matt	Elements of the air inlets, the tailgate and the rear bumper in high-gloss chrome
Cover of B-pillar, window guide rail and mirror base in high-gloss black	Cover of B-pillar, window guide rail and mirror base in high-gloss black
Weather strip and cover of window border in aluminium with satin finish	Weather strip and cover of window border in chrome
Door handles illuminated with chrome wedge	Door handles illuminated with chrome wedge
Cover of entrance illuminates with specific insert and model inscription	Cover of entrance illuminates with specific insert and model inscription
Remote key/ID transmitter in dark oyster with clasp in high-gloss chrome	Remote key/ID transmitter in black with clasp in high-gloss chrome
Sporty leather steering wheel in dark oyster or black	Sporty leather steering wheel in black
Upholstery in fabric, Dakota leather or nappa leather with line-specific seam pattern	Upholstery in Dakota leather or nappa leather with line-specific seam pattern

The package contents may vary depending on the development series and vehicle equipment.

5 Series LCI

2. Body

2.5. Luggage compartment



F07 LCI luggage compartment

The rear seats of the BMW 5 Series Gran Turismo were moved forward by 27 mm with the model revision. This design measure, as well as other changes to the luggage compartment trim panels, the storage shelf and the partition wall, the luggage compartment capacity was able to be enlarged by 60 liters to 500 liters.

5 Series LCI

3. Powertrain

3.1. Overview of engines

The engines which are used from the model revision in the BMW 5 Series are listed below.

Gasoline engines

Engine	Model	Development series	Power output [kW] (hp)	Torque [Nm] (lb-ft)
N20B20O0	BMW 528i BMW 528i xDrive	F10	180 (240)	350 (260)
N55B30M0	BMW 535i BMW 535i xDrive BMW ActiveHybrid 5	F07, F10	225 (300)	400 (300)
N63B44O1	BMW 550i BMW 550i xDrive	F07, F10	330 (445)	650 (480)

Diesel engines

Engine	Model	Development series	Power output [kW] (hp)	Torque [Nm] (lb-ft)
N57D30O1	BMW 535d BMW 535d xDrive	F10	190 (255)	560 (413)

All models of the BMW 5 Series LCI satisfy the exhaust emissions standard ULEV II. Diesel particulate filters are installed in all diesel-engine cars. In addition to SCR II exhaust emission system (Selective Catalytic Reduction II).

Further information on the SCR II exhaust emission system can be found in the Training Reference Manual "ST1307 Second Generation Diesel Emissions".

5 Series LCI

3. Powertrain

3.2. N57TU engine

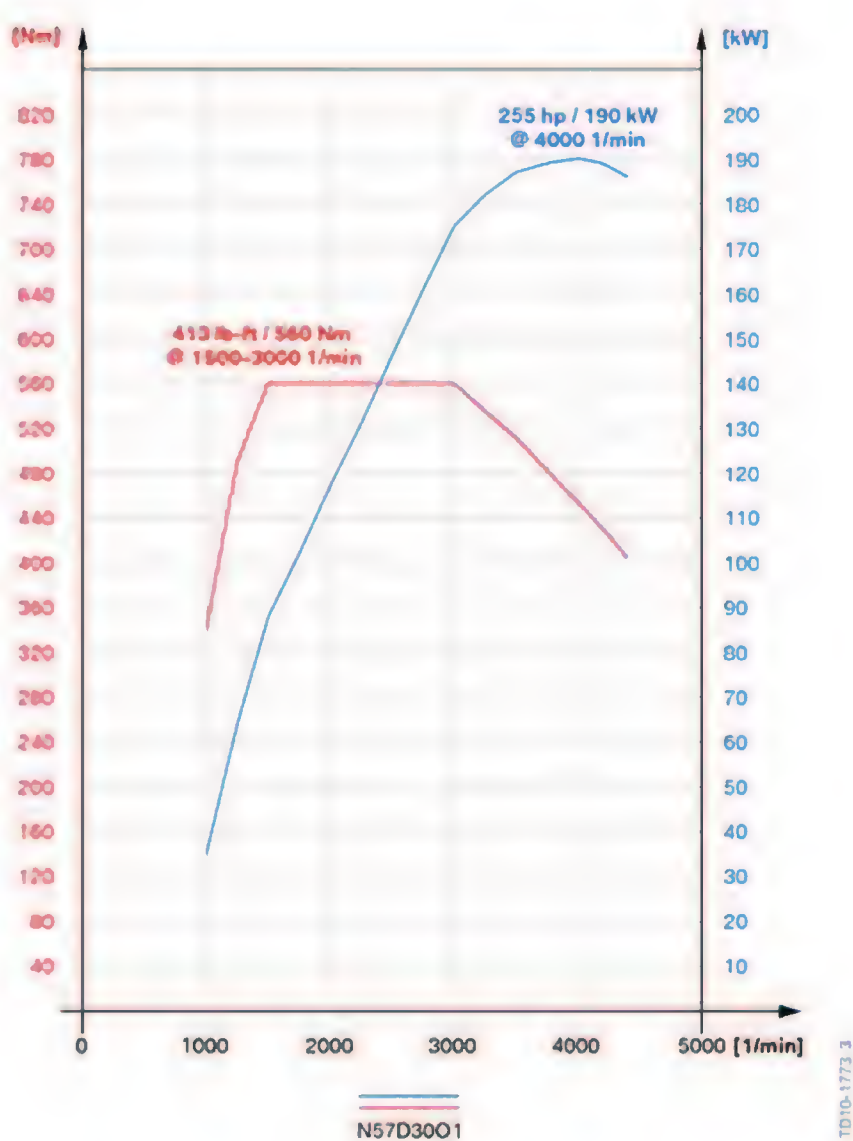

Full load diagram F10 LCI, 535d with N57D3001 engine

Further information on the N57TU engine can be found in the Training Reference Manual "ST1306 N57TU Diesel Engine".

5 Series LCI

3. Powertrain

3.3. N63TU engine

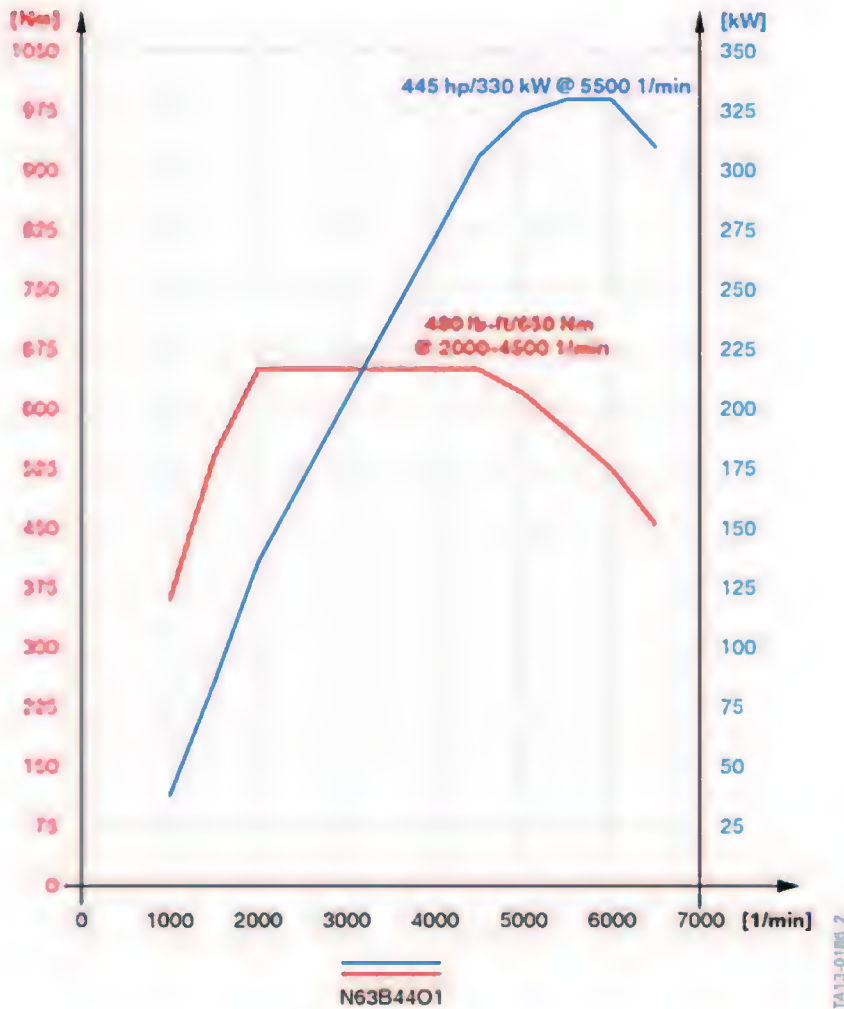

Full load diagram F10 LCI, 550i with N63B44O1 engine

In the F10 LCI and F07, the N63TU, is used in the variant N63B44O1.

3.3.1. Measures for CO₂ reduction

Even before the model revision of the BMW 5 Series, the N63TU engine was revised to reduce emissions.

Wider piston rings with an optimized coefficient of friction, made from a softer material, were installed. As these piston rings require lower piston ring grooves, the pistons were also modified accordingly.

Connecting rods without wrist pin bushings are used, the wrist pins also have a special carbon coating (DLC – Diamond-like carbon). The designation DLC refers to the diamond-like properties of this coating, which further optimized the coefficient of friction.

5 Series LCI

3. Powertrain



Connecting rod (B) without bushing in the N63TU engine

Index	Explanation
A	Connecting rod with bushing
B	Friction optimized connecting rod without bushing

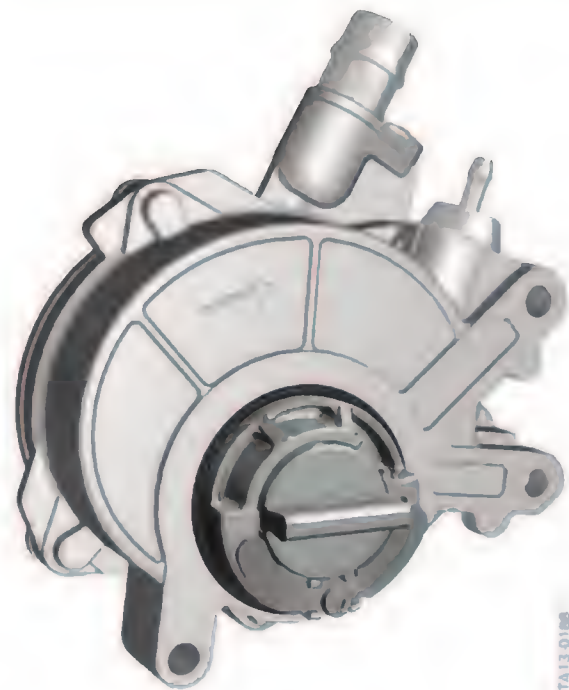

Vacuum pump, N63TU engine

A friction-optimized vacuum pump reduces fuel consumption by approximately 0.5%.

The standard automatic engine start-stop function also helps reduce emissions.

5 Series LCI

3. Powertrain

3.4. Automatic engine start/stop function

In the BMW 5 Series LCI the automatic engine start-stop function (MSA) is used for all engine versions.

The operating logic is known from the current BMW models.

In this chapter only the changes to the automatic engine start-stop function introduced with the BMW 5 Series LCI are described. A description of the entire system can be found in the Training Reference Manual "F31 Complete Vehicle" ST1301.

3.4.1. Longitudinal jolt

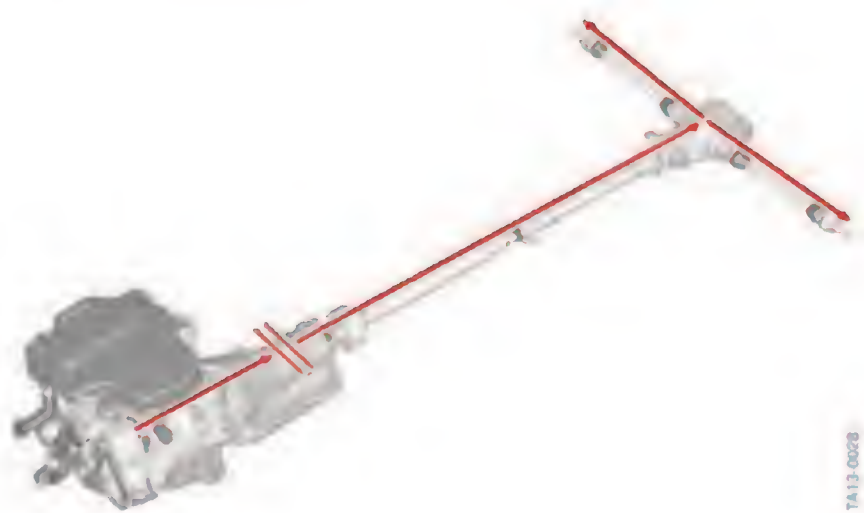

BMW 5 Series LCI drive train

In vehicles with an automatic transmission the drive train is preloaded by the engine torque and the stationary wheels, as soon as a drive position (R, D, S or M) is switched, when an engine is running and the brake pedal is pressed. If the engine is stopped by the automatic engine start-stop function in this state, the mechanical transmission oil pump is also no longer powered. As not enough transmission oil pressure can build up below a certain engine speed, a multidisc clutch in the automatic transmission is opened very quickly. This in turn means that the torque at the drive train drops suddenly, whereby a longitudinal jolt or shudder of the vehicle is felt.

To avoid this longitudinal jolt, a multidisc clutch is slowly opened in the automatic transmission immediately before the automatic engine shutdown which improves the comfort significantly.

This additional function was introduced in all vehicles with an automatic engine start-stop function and automatic transmission shortly before the model revision of the BMW 5 Series.

Other changes to the automatic engine start-stop function are introduced parallel to the model revision. In general, the time delay between vehicle standstill and an automatic engine shutdown is deleted, among other things (see next chapter). In this case the multidisc clutch in the automatic transmission is not opened before the automatic engine shutdown.

5 Series LCI

3. Powertrain

3.4.2. Stop delay

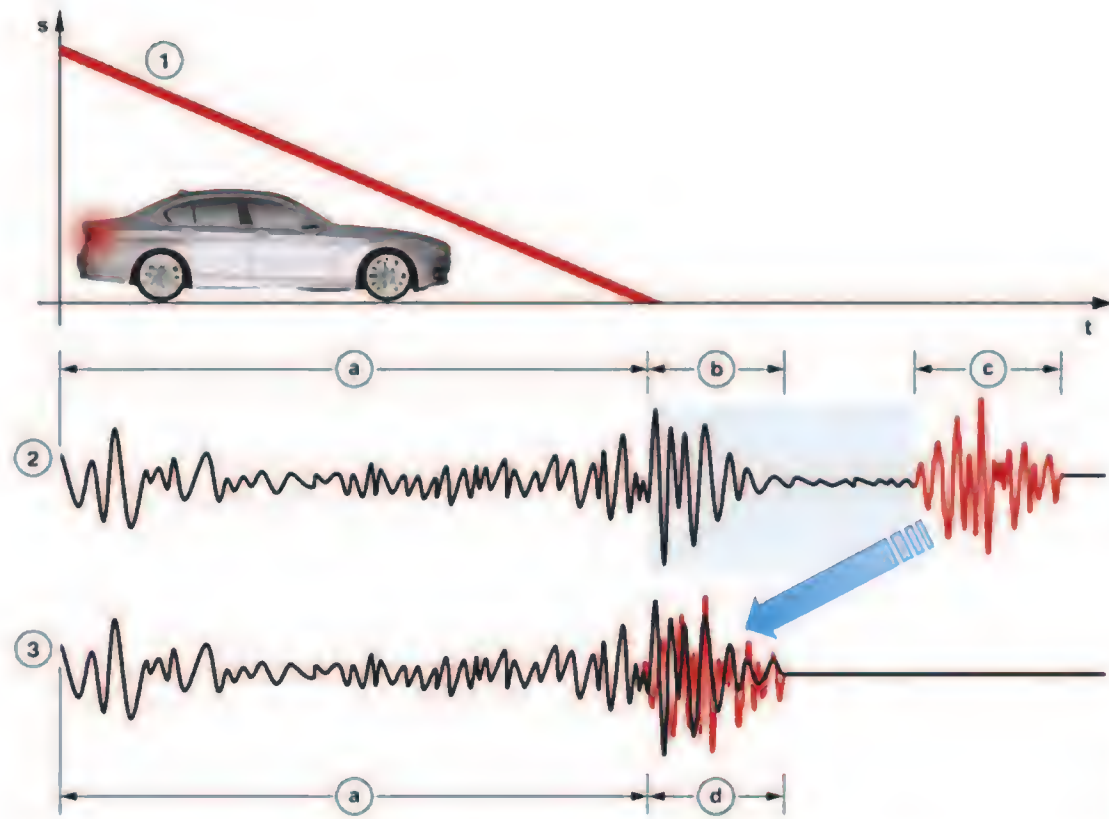

Automatic engine start-stop function without stop delay

Index	Explanation
1	Vehicle speed
2	Vehicle excitation (automatic engine start-stop function with stop delay)
3	Vehicle excitation (automatic engine start-stop function without stop delay)
a	Roadway excitation
b	Stopping jolt of the vehicle
c	Stopping the engine
d	Stopping jolt of the vehicle and engine (masked)

Similar to vehicles with manual gearbox, the time delay of approximately one second until the automatic engine shutdown (light blue area in the graphic) is now also deleted in vehicles with an automatic transmission. The engine is shut down immediately upon vehicle standstill ($v = 0$ mph). The shutdown of the engine is hardly noticeable as it is masked by the stopping jolt of the vehicle.

5 Series LCI

3. Powertrain

In special cases, the automatic engine shutdown can still be done shortly after the vehicle standstill, for example:

- by the driver such as steering wheel movement (for maintaining the power steering support)
- upon heavy braking (from 5 m/s²)
- on inclines or downhill gradients (from about 3.5%)

3.4.3. Start strategy

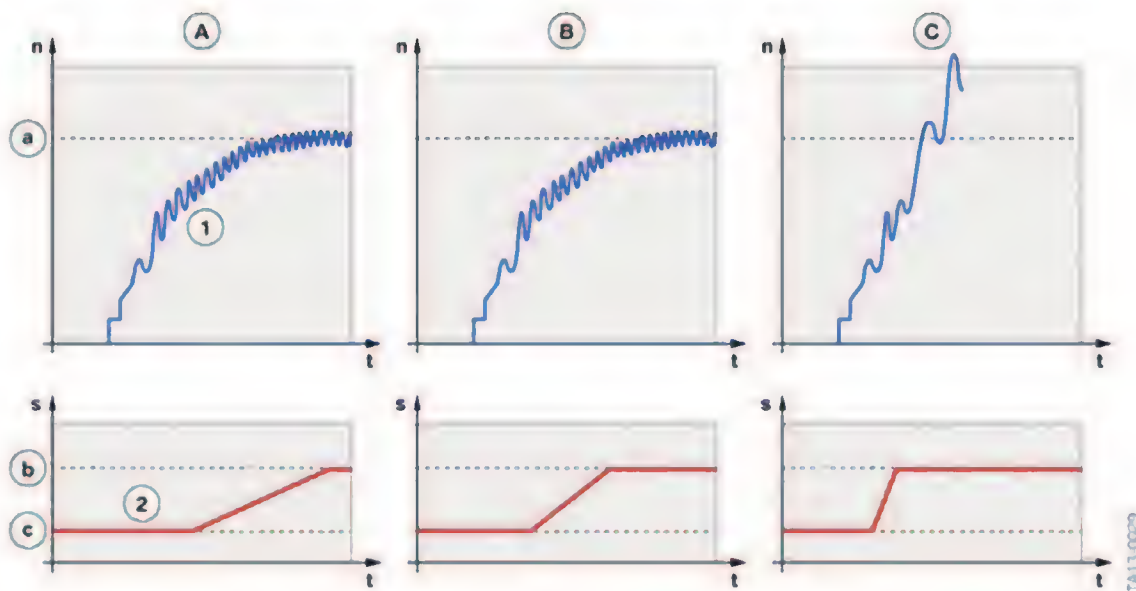

Automatic engine start-stop function start strategy

Index	Explanation
A	System start
B	Convenient starting
C	Dynamic start
1	Engine speed
2	Position of multidisc clutch
a	Idle speed
b	Multidisc clutch closed
c	Multidisc clutch open

5 Series LCI

3. Powertrain

Up to now, upon an automatic engine start by the automatic engine start-stop function, the engine speed was increased in every situation as quickly as possible to reach idle speed.

However, in order to guarantee quick drive off on the one hand, and to start the engine with fewer vibrations and without a noticeable longitudinal jolt of the vehicle on the other, the automatic engine start for the BMW 5 Series LCI with automatic transmission was optimized depending on the situation:

System start	Convenient starting	Dynamic start
The automatic engine start is executed by a system switch-on request (e.g. by air-conditioning), the brake pedal remains pressed.	The automatic engine start is executed by releasing the brake, the accelerator pedal is not pressed.	The automatic engine start is executed by releasing the brake, the accelerator pedal is pressed for drive off.
The engine speed is slowly increased until it reaches the idle speed.	The engine speed is slowly increased until it reaches the idle speed.	The engine speed is increased quickly.
The multidisc clutch in the automatic transmission closes very slowly.	The multidisc clutch in the automatic transmission closes slowly.	The multidisc clutch in the automatic transmission closes quickly.
A longitudinal jolt noticeable to the driver is avoided.	Smooth and comfortable drive-off is made possible.	Quick drive off is therefore made possible.

For an engine start with fewer vibrations, with the system start and convenient starting the engine speed is initially increased quickly and then slower until it reaches the idle speed. The ignition timing is retarded for this.

3.4.4. Starter motor

A new, more robust starter motor is used for the following engine versions:

- N57 engine
- N20 engine

While previously the starter motor was only actuated at engine standstill, the new starter motor can be actuated before the engine standstill, at an engine speed of 0 to approximately 150 rpm.

This is primarily used with a recognized switch-on prompt during an automatic engine shutdown by the automatic engine start-stop function. The customer therefore does not have to wait if he wants to continue driving straight away after an automatic engine shutdown, e.g. at a stop sign.

5 Series LCI

3. Powertrain

3.5. CO₂ measures

In the F10 LCI 550i with rear-wheel drive the CO₂ emissions were reduced.

- N63TU engine:
 - Piston rings with optimized coefficient of friction
 - Connecting rod without bushing and carbon-coated wrist pin
 - Friction-optimized vacuum pump
 - Deletion of the stop delay during an automatic engine shutdown of the automatic engine start-stop function in vehicles with an automatic transmission
- Automatic transmission 8HP70:
 - Changes when adjusting the converter lockup clutch in 1st gear (in comparison to its predecessor, in the F10 LCI 550i the converter lockup clutch can be closed in 1st gear in the lower and medium load range)
 - Longer overrun fuel cutoff (in comparison to its predecessor the fuel injection and ignition only start at a lower engine speed in the F10 LCI 550i)
- Ratio of the rear axle differential changed from 3.08 to 2.81
- Aerodynamic measures at vehicle underbody and wheel arch:
 - Enlargement of the underbody panelling at the fuel tank

3.6. Automatic transmission

3.6.1. Sports automatic transmission

The Sports automatic transmission (option 2TB) is only offered only in the F10 LCI.

Additional functions are available for the Sports automatic transmission with the model change:

- Three different shift speeds, depending on the driving dynamics setting.
- Suppression of automatic gear shifts in manual mode.
- Launch Control enables optimal acceleration when driving off on a smooth roadway. The system calculates an engine torque, at which a controlled slip of about 10 to 15% is allowed on a smooth roadway depending on conditions.

3.6.2. ConnectedShift

ConnectedShift uses navigation data for a forward-thinking shift strategy of the automatic transmission. If, for example, a sharp bend is detected, the automatic transmission shifts down early and the gear is retained in the bend.

The route guidance of the navigation system does not need to be activated for the function. However, the identification of a turn-off request, for example by the active route guidance or operating the turn indicator, helps to control the system more accurately. Up-to-date navigation map data also influences the control accuracy.

5 Series LCI

3. Powertrain

Advantages

ConnectedShift offers various advantages depending on the route:

Traffic guidance	Advantages
Bend/Subsequent bend	<ul style="list-style-type: none"> Higher engine braking effect before the bend Driving force reserve for accelerating from the bend Optimized shift characteristics in the bend.
Crossroads	<p>Upon recognized turn-off request by active route guidance or operation of the turn indicator:</p> <ul style="list-style-type: none"> Higher engine braking effect before crossroads Optimized shift characteristics in the crossroads.
Highway entrance/exit ramp	<ul style="list-style-type: none"> Higher engine braking effect before ramp Driving force reserve when merging.
Roundabout	<ul style="list-style-type: none"> Higher engine braking effect before the roundabout Driving force reserve before entry Optimized shift characteristics in the roundabout and in the exit.

Shift example for a vehicle with and without ConnectedShift

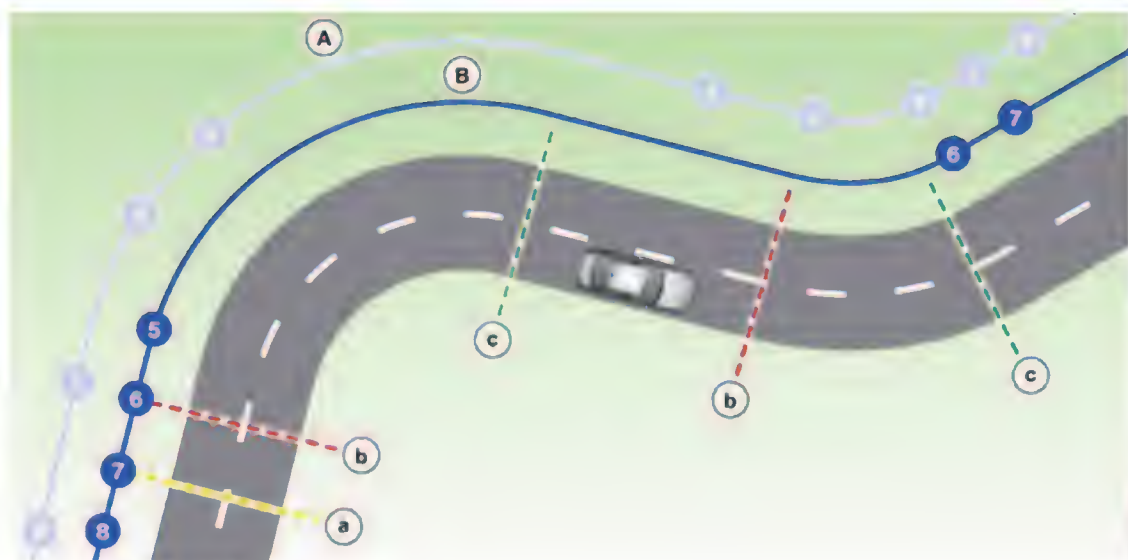

ConnectedShift shift example

TK 13 0032

5 Series LCI

3. Powertrain

Index	Explanation
A	Shift points without ConnectedShift
B	Shift points with ConnectedShift
a	Taking the foot off the gas (coasting (overrun) mode)
b	Slight brake control
c	Accelerator pedal is operated

ConnectedShift can choose downshifts before bends and avoid up and down shifts between consecutive bends. A higher engine braking effect before bends is thus achieved, as well as a reduction of the shift frequency in bends and optimal passage from the bends.

Characteristics and availability

In SPORT and COMFORT modes the characteristics of ConnectedShift are adapted to the respective driving program, in ECO PRO mode ConnectedShift is not available. ConnectedShift is also not available during control operation of cruise control.

With the exception of the BMW ActiveHybrid 5, ConnectedShift is used in the BMW 5 Series LCI for vehicles with automatic transmission and navigation system.

A prerequisite is that the navigation map data and the required additional information for the country are available. This is dependent on the navigation map provider and is not available worldwide for all countries.

3.6.3. Coasting in idle

With the exception of hybrid cars, the function "Coasting in idle" is available for all BMW 5 Series LCI with automatic transmission. Under certain prerequisites the engine is automatically disconnected from the transmission in gear selector switch position D. The engine runs here at idle speed.

Further information on "Coasting" is available in the "Training Reference Manual" ST1212 F01/F02 LCI, chapter Displays and Controls".

5 Series LCI

4. Chassis and Suspension

4.1. Electromechanical parking brake



Indicator light, parking brake

A functional enhancement of the electromechanical parking brake EMF enables an automatic release of the parking brake as soon as the drive-off request by the driver is recognized. Smooth and comfortable drive-off is made possible.

In the BMW 5 Series with automatic transmission this function has already been used since 2011 in the F10, this feature is now available in other BMW models with the EMF parking brake. With the model revision this function is now integrated in vehicles with manual gearbox.

The parking brake is automatically released as soon as there is a corresponding drive torque. In vehicles with an automatic transmission the accelerator pedal must also be pressed. In vehicles with manual gearbox the clutch must be released and at the same time the accelerator pedal pressed.

The following conditions must also be satisfied:

- Driver presence is identified, door closed and seat belt fastened
- Engine is running or driving readiness is displayed (BMW ActiveHybrid 5).
- Drive position/Gear engaged

In vehicles with manual gearbox the engaged gear is detected with help of the reverse gear switch and the zero-gear sensor. An engaged forward gear is identified if neither the reverse gear nor the neutral are shifted.

The driver's absence is detected via the seat belt buckle switch and by the door contact.

5 Series LCI

5. General Vehicle Electronics

5.1. Voltage supply

5.1.1. Deletion of DC/DC converter

In vehicles equipped with the automatic engine start-stop function (MSA), voltage dips in the vehicles electrical system occur more frequently due to the starter operations. Up to now a DC/DC converter was used to protect specific voltage-sensitive electrical components.

The last voltage-sensitive control units were replaced with the use of the Headunit High. With the use of the Headunit High, the DC/DC converter could be deleted in F10.

For F07 the interior light is supplied with voltage via the DC/DC converter. In the case of a voltage dip upon an engine start, it does not result in a change to the light intensity of the interior light. As this is still also desired, a DC/DC converter is still used in F07 .

5.1.2. Battery

An AGM battery with a capacity of 105 Ah has been installed in the following vehicles since July 2012:

- All vehicles in the F07 series
- All F10 N63TU engine

5 Series LCI

5. General Vehicle Electronics

5.2. Bus systems

5.2.1. Bus overview

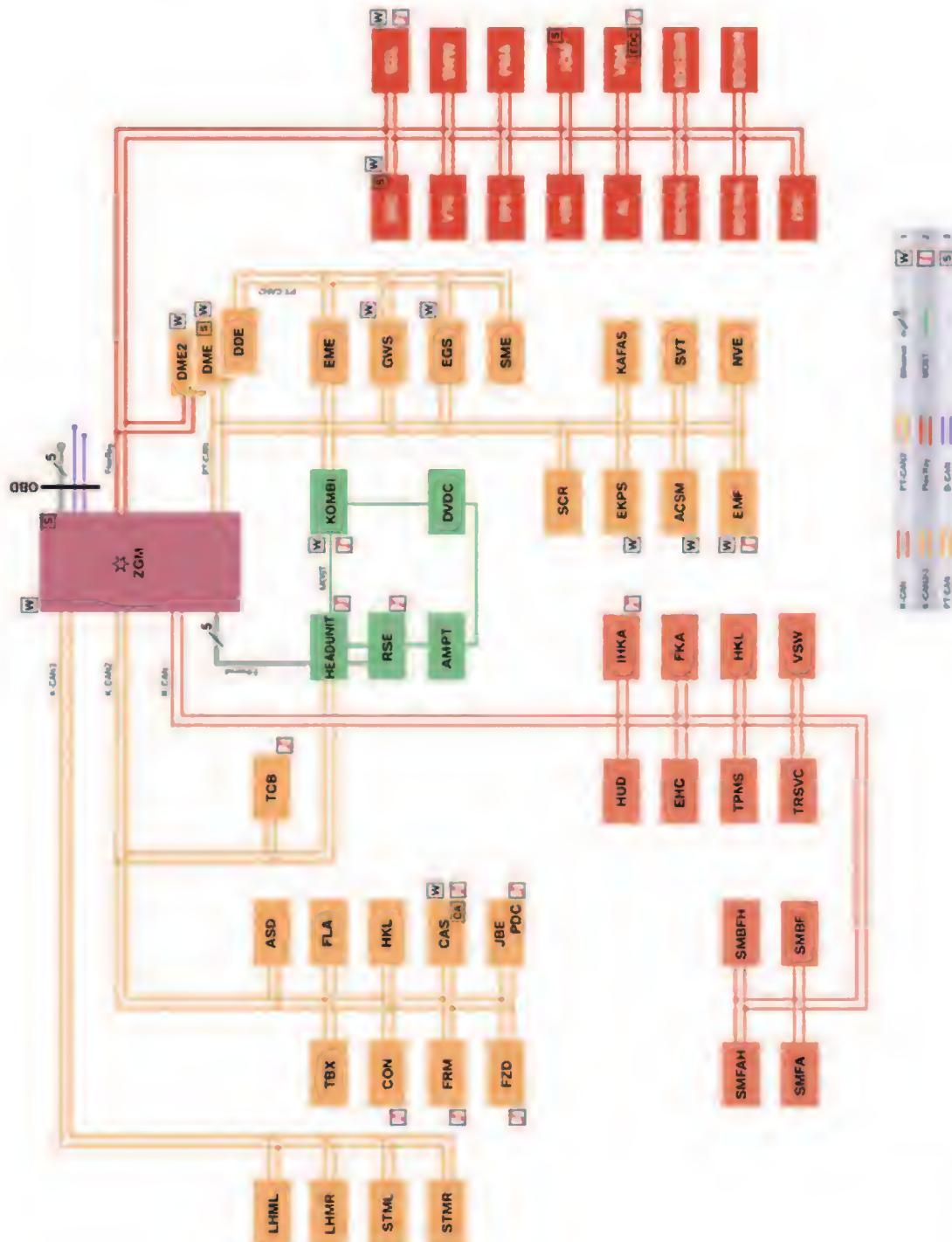

BMW 5 Series LCI Bus overview, includes hybrid and diesel

5 Series LCI

5. General Vehicle Electronics

Index	Explanation
1	Control units with wake-up line
2	Control units with wake-up authorization
3	Start-up node control units for starting and synchronizing the FlexRay bus system
ACSM	Advanced Crash Safety Module
AL	Active Steering
AMPT	Top HiFi Amplifier
ASD	Active Sound Design
CA	Comfort Access
CAS	Car Access System
COMBOX	Combox
CON	Controller
DDE	Digital Diesel Electronics
DME	Digital Engine Electronics
DME2	Digital Engine Electronics 2 (only N63TU engine)
DSC	Dynamic Stability Control
DVDC	DVD Changer
EDC	Electronic Damper Control
EDCSHL	Electronic Damper Control Satellite, rear left
EDCSHR	Electronic Damper Control Satellite, rear right
EDCSVL	Electronic Damper Control Satellite, front left
EDCSVR	Electronic Damper Control Satellite, front right
EGS	Electronic Transmission Control
EHC	Electronic Ride Height Control
EKPS	Electronic Fuel Pump Control
EME	Electrical Machine Electronics (only for hybrid cars)
EMF	Electromechanical Parking Brake
EPS	Electromechanical Power Steering
FKA	Rear Climate Control
FLA	High-beam Assistant (integrated in the camera-based driver support systems control unit for vehicles with Driving Assistant 5AS, Driving Assistant Plus 5AT or Road Sign Recognition 8TH)
FRM	Footwell Module
FZD	Roof Function Center
GWS	Gear Selector
HEADUNIT	Headunit (Headunit High)

5 Series LCI

5. General Vehicle Electronics

Index	Explanation
HKL	Automatic Luggage Compartment Lid Actuation (F07 LCI, F10 LCI, at the K-CAN)
HSR	Rear Axle Slip Angle Control
HUD	Head-Up Display
ICM	Integrated Chassis Management
IHKA	Integrated Automatic Heating / Air Conditioning
JBE	Junction Box Electronics
KAFAS	Camera-Based Driver Support Systems
KOMBI	Instrument Panel
LHML	LED Main Light Module, left
LHMR	LED Main Light Module, right
NVE	Night Vision Electronics
PDC	Park Distance Control (integrated in the Junction Box Electronics)
PMA	Parking Maneuvering Assistant
TPMS	Tire Pressure Monitoring System
RSE	Rear Seat Entertainment System
SCR	Selective Catalytic Reduction (DCU, Dosing Control Module)
SMBF	Seat Module, Passenger
SMBFH	Seat Module, Passenger, Rear
SME	Battery Management Electronics (only hybrid cars)
SMFA	Seat Module, Driver
SMFAH	Seat Module, Driver, Rear
STML	Left-hand Headlight Driver Module
STMR	Right Headlight Driver Module
SVT	Servotronic
SWW	Lane Change Warning
SZL	Steering Column Switch Cluster
TBX	Touchbox
TCB	Telematic Communication Box
TRSVC	Control Unit for Reversing Camera and SideView
VDM	Vertical Dynamics Management
VSW	Video Switch
VTG	Transfer Box (xDrive only)
ZGM	Central Gateway Module

5 Series LCI

5. General Vehicle Electronics

In vehicles with an Adaptive LED headlight (option 552) with Adaptive Headlight (option 524) the vehicle electrical system of the BMW 5 Series LCI was extended with a further data bus, the K-CAN3. This data bus controls the headlights for illumination, the two headlight driver modules or LED main light module. The K-CAN3, which can be easily accessed from the outside, was implemented and secured separately from the other bus systems in order to prevent manipulations at the vehicle.

5.2.2. MOST

With the introduction of the Headunit High in July 2012, the MOST connection to the central gateway module (ZGM) is no longer used. It is still possible to update the map data via the Ethernet interface of the headunit or via USB.

5.3. Exterior lights

With the model revision the BMW 5 Series is equipped as standard with bi-xenon headlights. The halogen headlights are no longer used. In addition, headlights and fog lights with LED technology are now available for vehicles of the BMW 5 Series. The following table provides an overview of the equipment specifications:

Designation	Standard/Optional Equipment
Bi-xenon headlights with Adaptive Headlights	Standard
Full LED headlights	Option 552
LED fog lights	Option 5A1

5.3.1. Bi-xenon headlights

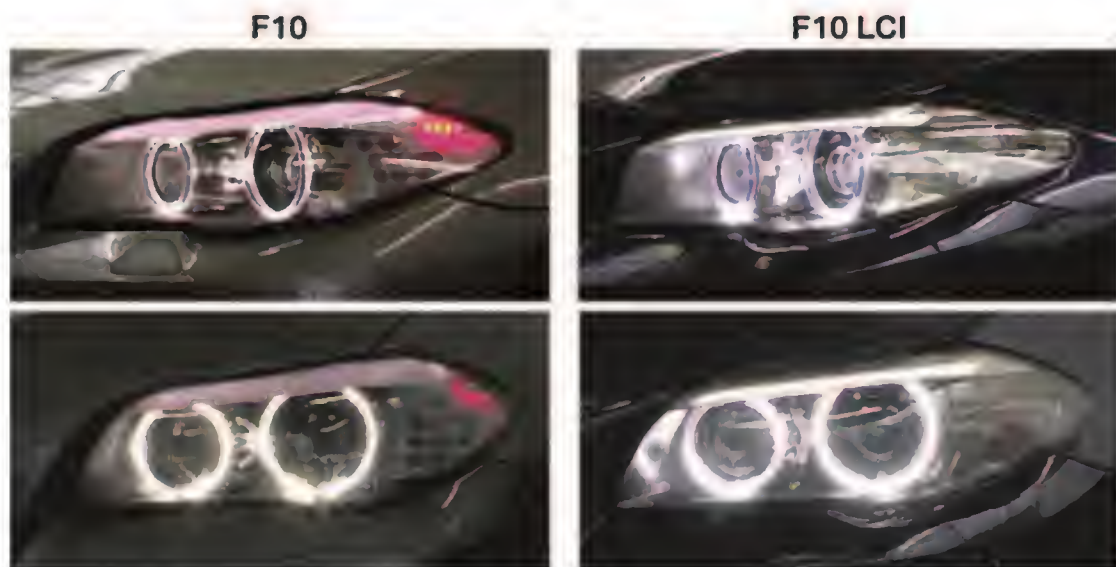

F10 LCI bi-xenon headlight

5 Series LCI

5. General Vehicle Electronics

The technical features of the bi-xenon headlight previously available as option 522 is now used as standard in the BMW 5 Series.

The lighting rings and the positioning lights with exposed optical fibre are still implemented in LED technology.

The appearance of the turn indicator was changed. They were also converted to bulbs in the F10 LCI, as the previous LEDs were too strong. The LEDs are still used in the F07 LCI.

5.3.2. Bi-xenon headlight with Adaptive Headlight

This chapter describes the bi-xenon headlight with Adaptive Headlight in the F10 LCI. In the F07 LCI the bi-xenon headlights with Adaptive Headlight were adopted from the predecessor. No changes were made to the technical features. They are therefore not mentioned here.

5.3.3. Adaptive LED headlight

Optional adaptive LED headlights (option 552) are available for the BMW 5 Series LCI. The similar to daylight color temperature allows the LED light to appear even brighter and therefore ensures even greater comfort and safety. Particularly traffic signs and other reflective objects appear higher in contrast and can be subjectively better perceived. The technology used is known from the F12 and F13.

The LED full headlight has a low-beam headlight which is made from numerous LEDs and an additional reflector. Unlike the Xenon, the cornering light has the same light color as the low-beam headlight. It is convincing with its very bright and clear illumination of the entire area of the road being turned onto.

Both the outer and inner reflectors of the headlight are used for the high-beam headlight.

Automatic High-beam Assistant is available as an option (option 5AC).

5 Series LCI

5. General Vehicle Electronics



F10 LCI LED headlight, left

TE 13 0104

Index	Explanation
1	Cornering light LED module
2	Left-hand headlight driver module, STML
3	LED main light module on the left, LHML

5 Series LCI

5. General Vehicle Electronics

LED main light module

The LED main light module is fitted to the underside of the LED headlight and controls the following lighting functions:

- Low-beam headlight
- High-beam headlight
- Headlight flasher
- Cornering lights

The LED main light module additionally controls the temperature control in the LED headlights. After switching off the lighting functions an after-run of the fans of up to 60 s is possible.

In the case of a failure of a temperature sensor the fans are switched on at full power to protect the components in the LED headlight. The data from the LED main light module is transferred to the footwell module FRM for the diagnosis of the fans and temperature sensors.

Headlight driver module

The headlight driver module is installed as a printed circuit board in the LED headlight. The following lighting functions are controlled:

- Side lights
- Daytime lights
- Side marker light
- Turn indicator
- Positioning light

The control of the stepper motors for the headlight beam throw adjustment and the Adaptive Headlight is also assumed from the headlight driver module.

Cornering light LED module

The cornering light LED module is installed as an additional light source in the LED headlight. Through corresponding encoding country-specific settings are possible. For example, in the Korea national-market version the cornering light is not available.

The modular design allows the interchangeability of the cornering light LED module in the existing LED headlight.

Emergency operation

If there is a fault in the footwell module (FRM) that could lead to the failure of an LED headlight, then an emergency operation is activated via the LED main light module. In the case of a fault in the LED main light module the emergency operation is activated via the footwell module FRM. The driving light remains switched on until the vehicle is stopped. The driver is warned of the malfunction in the instrument cluster (KOMBI) as a Check Control message.

5 Series LCI

5. General Vehicle Electronics

System wiring diagram

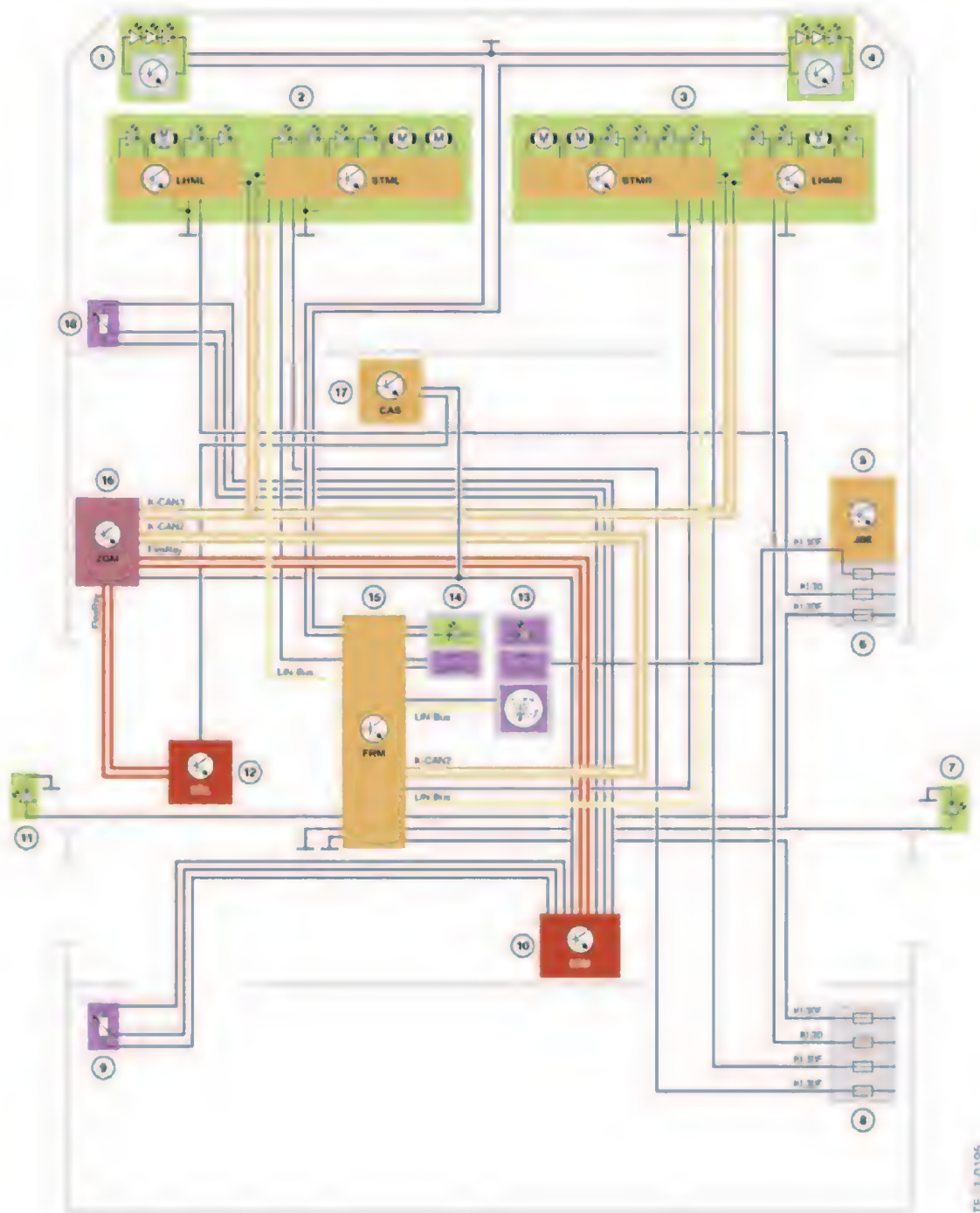

TE 3 0195

BMW 5 Series LCI System wiring diagram for adaptive LED headlight

5 Series LCI

5. General Vehicle Electronics

Index	Explanation
1	LED Fog Light, left (option 5A1)
2	Headlight, left ¹
3	Headlight, right ²
4	LED Fog Light, right (option 5A1)
5	Junction Box Electronics (JBE)
6	Junction Box for the Power Distribution Box
7	Additional Turn Indicator in Exterior Mirror, right
8	Power Distribution Box, luggage compartment
9	Ride Height Sensor, rear
10	Integrated Chassis Management (ICM)
11	Additional Turn Indicator in Exterior Mirror, left
12	Steering Column Switch Cluster (SZL)
13	Operating Facility, Light Switch
14	Central Locking Button/Hazard Warning Switch
15	Footwell Module (FRM)
16	Central Gateway Module (ZGM)
17	Car Access System (CAS)
18	Ride Height Sensor, front

¹ Including the LED main light module on the left LHML with fan and LEDs for cornering light, low-beam headlight and high-beam headlight, as well as the left-hand headlight driver module (STML) with stepper motors for headlight beam throw adjustment and Adaptive Headlight and LEDs for side marker light, positioning light, side lights/daytime driving lights and turn indicator.

² Including the LED main light module on the right LHMR with fan and LEDs for cornering light, low-beam headlight and high-beam headlight, as well as the right-hand headlight driver module (STMR) with stepper motors for headlight beam throw adjustment and Adaptive Headlight and LEDs for side marker light, positioning light, side lights/daytime driving lights and turn indicator.

5 Series LCI

5. General Vehicle Electronics

5.3.4. Fog light



F10 LCI LED fog light

LED fog lights (option 5A1) can also be ordered for the BMW 5 Series LCI as optional equipment. Covers are installed in the bumper in place of the fog lights in the basic equipment.

5.3.5. Rear exterior lights



F07 LCI rear light

In the F07 LCI, rear lights with modified geometry are installed. Technical changes were not made.

5 Series LCI

5. General Vehicle Electronics



F10 LCI rear light

The rear lights of the F10 LCI are now characterized by turn indicators illuminated indirectly with LEDs and narrower tail lights. The shape of the rear lights is the same.

5.4. Ambiance lighting

The ambiance lighting in the BMW LCI can now be adjusted via the controller in the central information display CID. Firstly, the two light colors orange or white can be selected, then the brightness can be adjusted. The brightness setting takes precedence over the adjustment to the instrument lighting.



Adjustment of ambient lighting in the BMW 5 Series LCI

5 Series LCI

5. General Vehicle Electronics

5.5. Contactless tailgate activation

All BMW 5 Series LCI with CA (option 322) have the contactless rear lid actuation known from the F30. In vehicles with automatic luggage compartment lid actuation (option 316), the foot movement in the BMW 5 Series LCI can now also activate the closing action of the tailgate. An acoustic warning device is integrated in the tailgate, which is activated upon closing.

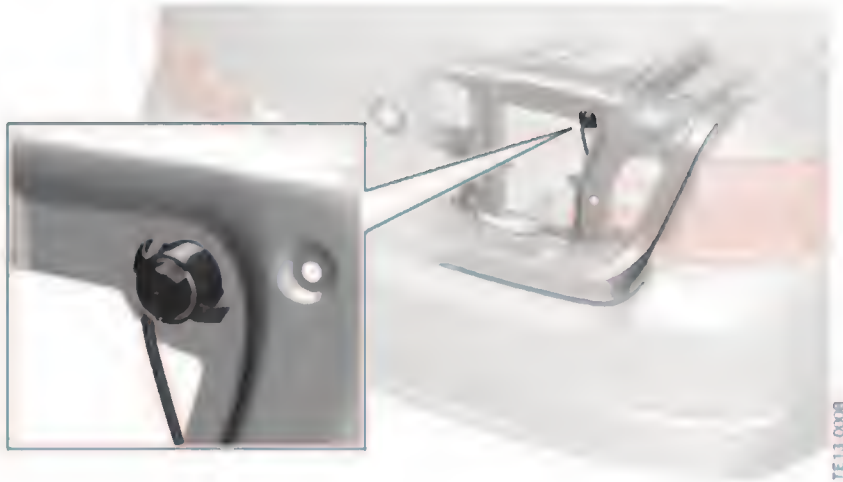

F07 LCI acoustic warning device for tailgate activation

The acoustic warning device is only installed in the F07 LCI and is located under a cover in the upper area of the tailgate.

5 Series LCI

6. Driver Assistance Systems

The comprehensive package of assist systems for the BMW 5 Series LCI has been modified and supplemented. The changes are based on those of the F01/F02 LCI.

The assist systems facilitate driving of the vehicle by:

- providing the driver with information,
- giving the driver suggestions or
- automatically intervening in the driving process.

In this chapter you obtain an overview of the following assist systems:

- BMW Night Vision with person recognition
- Lane departure warning
- Camera-based collision warning (including pedestrian warning with city braking function and collision warning with city braking function)
- Radar-based collision warning with braking function
- Speed limit information
- Active cruise control with Stop & Go function ACC Stop & Go

Further information on the assist systems can be found in the product information bulletin of the F01:

- "BMW Night Vision 2"
- KAFAS F01/F02
- "DCC, ACC F01/F02"
- "F01 Driving Stability Control"

6.1. Overview of optional equipment

With the introduction of the optional equipment Active Driving Assistant (option 5AS) and ACC Stop & Go + Active Driving Assistant (option 5AT) some of the assist systems are available individually and some as part of the two new options. The following table provides an overview.

Optional equipment	Function
5AS Active Driving Assistant	Lane departure warning Camera-based collision warning Forward collision warning with city braking function Pedestrian warning with city braking function
5AT ACC Stop & Go + Active Driving Assistant	Lane departure warning Forward collision warning with braking function Pedestrian warning with city braking function ACC Stop & Go Distance information (only in conjunction with Head up display (option 610))
5AG	Active Blind Spot Detection
8TH	Speed Limit Info

5 Series LCI

6. Driver Assistance Systems

Optional equipment	Function
610	BMW Head-Up Display Distance information (only in conjunction with option 5AT)
5DP	Parking Assistant
508	Park Distance Control (PDC)
5AC	Automatic High-Beams (with option 552)
6UK	BMW Night Vision with Pedestrian Detection
3AG	Rearview Camera
5DL	Side and Top View Cameras

6.2. Overview of sensors

The following table provides an overview of which assist systems are implemented with radar sensor, KAFAS camera and Night Vision camera. The same system can be used with different sensors depending on the equipment. Observe the information in the descriptions of the individual systems.

Function/Sensor system	KAFAS camera	Radar sensor	Night Vision camera
Lane departure warning	X		
Active blind spot detection		X	
Speed limit info	X		
ACC Stop & Go	X	X	
Collision warning with braking function	X	X	
Camera-based collision warning	X		
Collision warning with city braking function	X		
Pedestrian warning with city braking function	X		
Automatic high-beams	X		
BMW Night Vision with pedestrian detection.			X

6.3. BMW Night Vision

At night BMW Night Vision detects, in optimum conditions, persons and animals up to 100 m / 320 feet away.

5 Series LCI

6. Driver Assistance Systems



BMW 5 Series LCI Night Vision camera

Index	Explanation
1	Night Vision camera

For further information on BMW Night Vision, please refer to the product information bulletin "BMW Night Vision 2".

6.3.1. BMW Night Vision with pedestrian and animal recognition

The operation and the warning function of the optional equipment BMW Night Vision with person recognition (option 6UK) have been modified. Details of the new features are provided in the following.

Operation

System person recognition, or the pedestrian warning front protective function, is automatically activated after each engine start via the START/STOP button.

When the Night Vision button is pressed in the driver assistance system operating facility, the image from the Night Vision camera is shown in the central information display (CID). The driver can adjust the brightness and the contrast here.



BMW 5 Series LCI display Night Vision with detected people

5 Series LCI

6. Driver Assistance Systems

The pedestrian warning is switched on and off via the Intelligent Safety button.



BMW 5 Series LCI Intelligent Safety button

Index	Explanation
1	Intelligent Safety

Using the Intelligent Safety button the following front protection functions of the collision warning, collision warning with braking function and BMW Night Vision can be activated and deactivated depending on the equipment in the vehicle.

- Collision warning (camera-based collision warning and collision warning with braking function)
- Pedestrian warning (pedestrian warning with city braking function and BMW Night Vision)

If only one function is available in the vehicle, the function is switched on or off each time the button is pressed and the LED above the button is turned on or off respectively. If both functions are installed in the vehicle, a menu appears in the CID when the button is pressed in which the functions can be individually switched on or off. The LED above the button illuminates as soon as at least one of the functions is switched on. The front protection functions are automatically switched on each time the engine is started via the START-STOP button.

Warning function

The system issues a warning when BMW Night Vision detects a person (pedestrian) or an animal within the warning range. The warning range is dependent on the driving speed and the steering angle. The warning threshold values are also dependent on whether the pedestrian or the animal is moving or standing still. This is demonstrated in the following graphic.

5 Series LCI

6. Driver Assistance Systems

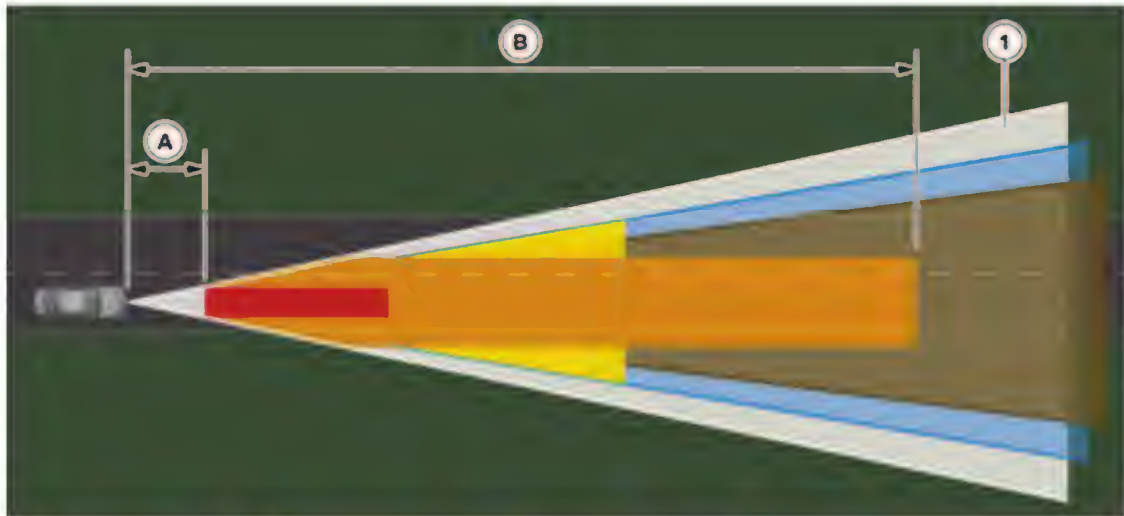

TE13 0215

BMW 5 Series LCI Night Vision warning ranges

Index	Explanation
A	Minimum distance approx. 10 m / 32 feet
B	Maximum distance for early warning of pedestrians approx. 100 m / 328 feet
1	Detection range of Night Vision camera (opening angle approx. 24°)
2	Warning range acute warning
3	Warning range early warning (person is on the roadway)
4	Warning range early warning (pedestrian crosses the roadway)
5	Warning range early warning (animal moves or crosses the roadway)
6	Warning range early warning (animal is beside or on the roadway)

5 Series LCI

6. Driver Assistance Systems

The pedestrian or animal warning appears in the instrument cluster or in the head-up display.

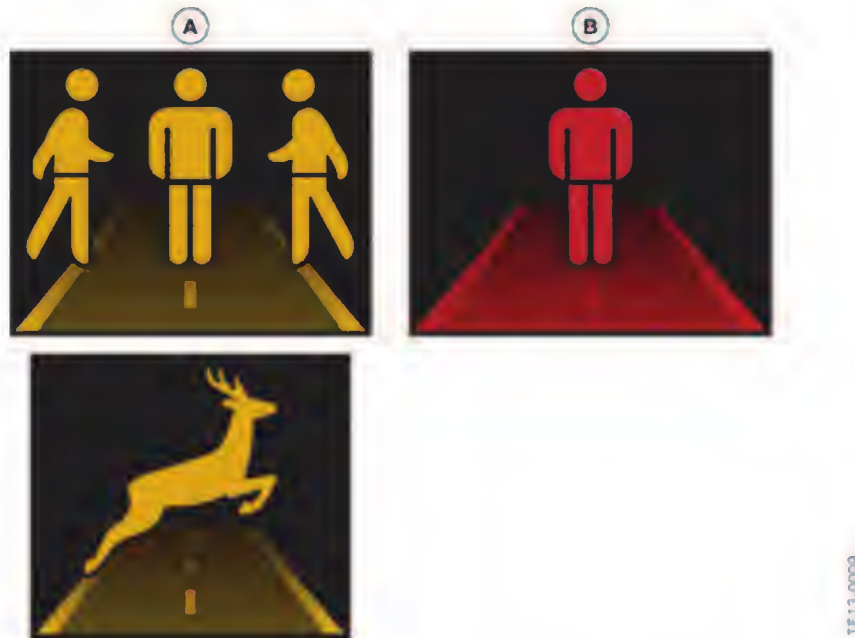

BMW 5 Series LCI Pedestrian or animal warning in the display of the instrument cluster and in the Head-Up Display

Index	Explanation
A	Stage 1: Early warning, pedestrian or animal is on the roadway or crosses the roadway. The symbol shows in which side the pedestrian or animal is located.
B	Stage 2: Acute warning, flashing person in red and acoustic warning signal. The brake system is prepared and the brake assistant is adapted. There is no acute warning for animals.

The early warning is executed when a pedestrian or animal is identified within the warning range. The early warning shows - depending on where the person or animal is situated - a person or animal lit yellow who is located within the lane or is moving on it. Animals from a certain size can be identified, e.g. deer.

The acute warning is only displayed in the case of an immediate risk of collision. The point at which the acute warning is issued is calculated in such a way that a collision can only be avoided by immediate emergency braking or by an evasive maneuver. With the acute warning the brakes of the vehicle are prepared for emergency braking.

The acute warning in the instrument cluster and in the Head-Up Display shows a flashing person in the roadway in red. In addition, an acoustic warning signal is sounded.

There is no acute warning for animals.



The acute warning does not relieve the driver of their responsibility to adapt their driving speed and driving style to the road and traffic conditions.

5 Series LCI

6. Driver Assistance Systems

The pedestrian or animal warning is executed irrespective of the representation of the Night Vision camera image in the central information display CID.

The warning is no longer shown in the CID, but instead appears exclusively in the instrument cluster or in the head-up display. If the Night Vision camera image is active both identified pedestrians and animals are shown in yellow.



BMW 5 Series LCI Night Vision camera image for identified animals on the central information display

6.4. Lane departure warning

The lane departure warning is an element of the optional equipment Active Driving Assistant (option 5AS) and the optional equipment ACC Stop and Go + Active Driving Assistant (option 5AT) and is unchanged. The lane departure warning warns the driver by vibrations in the steering wheel of the inadvertent departure from a given lane. The prerequisite for this is the presence of suitable roadway or lane markings, which can be recognized with the KAFAS camera of the control unit.

5 Series LCI

6. Driver Assistance Systems



BMW 5 Series LCI Lane departure warning



The system cannot replace a personal assessment of the roads and traffic situation. The lane departure warning merely supports the driver.

Observe the information in the section "Functional limitations".

6.4.1. Functional limitations

The function of the KAFAS camera and thus also the function of the corresponding assist systems may be impaired for example in the following situations:

- Heavy fog, rain, or snow
- Strong light in the camera lens
- If the field of view of the KAFAS camera or the windscreen is dirty or concealed
- On sharp bends
- Up to 10 seconds after an engine start via the START-STOP button
- During the calibration process of the KAFAS camera immediately after vehicle delivery or a camera change



System and functional limitations mean that warnings and bans may under certain circumstances not be issued or are issued too late or without authorization. The driver must therefore always remain alert and observant so that they can actively intervene at any time so as to avoid the risk of an accident.

6.5. Camera-based collision warning (option 5AS)

The camera-based collision warning is part of the optional equipment, Active Driving Assistant (option 5AS). The collision warning alerts the driver of a possible collision danger using the input from the KAFAS camera system. The camera-based collision warning was extended in the BMW 5 Series

5 Series LCI

6. Driver Assistance Systems

LCI (compare to the 7 Series LCI) with the functions collision warning with city braking function and pedestrian warning with city braking function. The system is available as part of the ZDB Driver Assistance Plus package.

The ZDB Driver Assistance Plus package includes:

- Active Blind Spot Detection (5AG)
- Active Driving Assistant (5AS)
- Or the ACC stop and Go + Active Driving Assistant (option 5AT)

Active Driving Assistant (5AS)

- KAFAS camera based
- Collision warning Pedestrian warning (daytime)
- Brake application

ACC Stop & Go + Active Driving Assistant (5AT)

- KAFAS camera
- Radar sensor

You can find a comparison of the camera-based collision warning and collision warning with braking function in the chapter "Collision warning with braking function".

6.5.1. Functional principle

The KAFAS camera records the scenery ahead of the vehicle and uses image processing to detect the complete rear views of moving and stationary vehicles in the field of view.



BMW 5 Series LCI KAFAS camera

5 Series LCI

6. Driver Assistance Systems

Index	Explanation
1	KAFAS camera
2	Rain-light-solar-condensation sensor
3	Photosensor for brightness in front for the automatic-dim feature of the electrochromic inside mirror



Example of vehicle identification by KAFAS camera

Index	Explanation
1	Vehicle in same lane
2	Vehicle in different lane

The corresponding warning stages, early warning and acute warning are output in critical situations on the basis of the calculated positions, distances and relative speeds of the other vehicles. For the early warning, the brakes of the vehicle are prepared for emergency braking and the activation thresholds of the brake assistants are reduced.

In the event of a deliberate forward collision with a vehicle, the system sensitivity is reduced in order to avoid unwarranted and thus annoying warnings.

Collision warning with city braking function

The collision warning with city braking function extends the camera-based collision warning with a braking function from a speed of roughly 5 km/h / 5 mph up to a maximum speed of 60 km/h / 37 mph. If there is still no driver response in this speed range after an acute warning, the vehicle is decelerated at an acceleration of maximum 4 m/s².

The brake intervention is restricted to roughly 1.5 seconds. This avoids additional dangers for the following traffic.

At speeds over 60 km/h / 37 mph a warning without brake intervention is executed as before.

5 Series LCI

6. Driver Assistance Systems

Pedestrian warning with city braking function

The pedestrian warning with city braking function is designed to prevent possible collisions with pedestrians in urban areas or lessen the results of an accident. In sufficient daylight the system identifies a possible collision with a pedestrian, warns the driver early and introduces emergency braking in the event of an unavoidable collision by the driver in order to reduce the vehicle kinetic energy.

The system provides a warning against a collision with pedestrians from a speed of roughly 10 km/h / 6 mph up to a maximum speed of 60 km/h / 37 mph.

The KAFAS camera records the scenery ahead of the vehicle and uses image processing to detect pedestrians in the field of view. An acute warning is output in critical situations on the basis of the calculated positions, distances and the movement of the identified pedestrians. An early warning is not output for the pedestrian warning with city braking function. With an acute warning the vehicle is decelerated at an acceleration of maximum 4 m/s².

At night the pedestrian warning with city braking function in vehicles with BMW Night Vision is automatically switched off and replaced with the pedestrian warning of the BMW Night Vision. At night only a warning function for pedestrians is available in vehicles with BMW Night Vision. There is no braking function. The change of the systems is not pointed out to the driver.

In vehicles without BMW Night Vision the pedestrian warning with city braking function also remains activated at night. However, the identification of pedestrians using the KAFAS camera is severely restricted at night due to the lighting conditions.

6.5.2. Operation

The collision warning and pedestrian warning are switched on and off via the Intelligent Safety button.



BMW 5 Series LCI Intelligent Safety button

Index	Explanation
1	Intelligent Safety

The new Intelligent Safety button replaces the previous button for the collision warning. Using the Intelligent Safety button the following front protection functions of the collision warning and BMW Night Vision systems can be activated and deactivated depending on the equipment in the vehicle.

- Collision warning
- Pedestrian warning (pedestrian warning with city braking function and BMW Night Vision)

5 Series LCI

6. Driver Assistance Systems

A menu appears in the CID when the button is pressed in which the functions can be individually switched on or off. The LED above the button illuminates as soon as at least one of the functions is switched on. The front protection functions are automatically switched on each time the engine is started via the START-STOP button.

From the information pages on Intelligent Safety you can also get to the menus for adjusting the warning time of the collision warning.



BMW 5 Series LCI Displays on the central information display

When the collision warning is activated the driver can set the time of the early warning in three stages. The setting of the time of the early warning is saved for the current driver profile. The warning time for the pedestrian warning cannot be adjusted.

6.5.3. Warning and braking function

This function is a camera-based assist system which can avoid accidents with pedestrians or vehicles or can lessen the results of an accident in the event of a collision. The operating principle is based on an identification and warning algorithm. The image processing identifies pedestrians and vehicles in the detection range of the camera. Using a motion prediction a risk of a collision is calculated taking into consideration the vehicle movement. If a situation is evaluated as critical by the warning algorithm, a warning is output and braking executed based on a multistage warning concept. The warnings and brake interventions are different for pedestrians and vehicles.

5 Series LCI

6. Driver Assistance Systems

Displays

The warning function appears in the instrument cluster or in the head-up display.

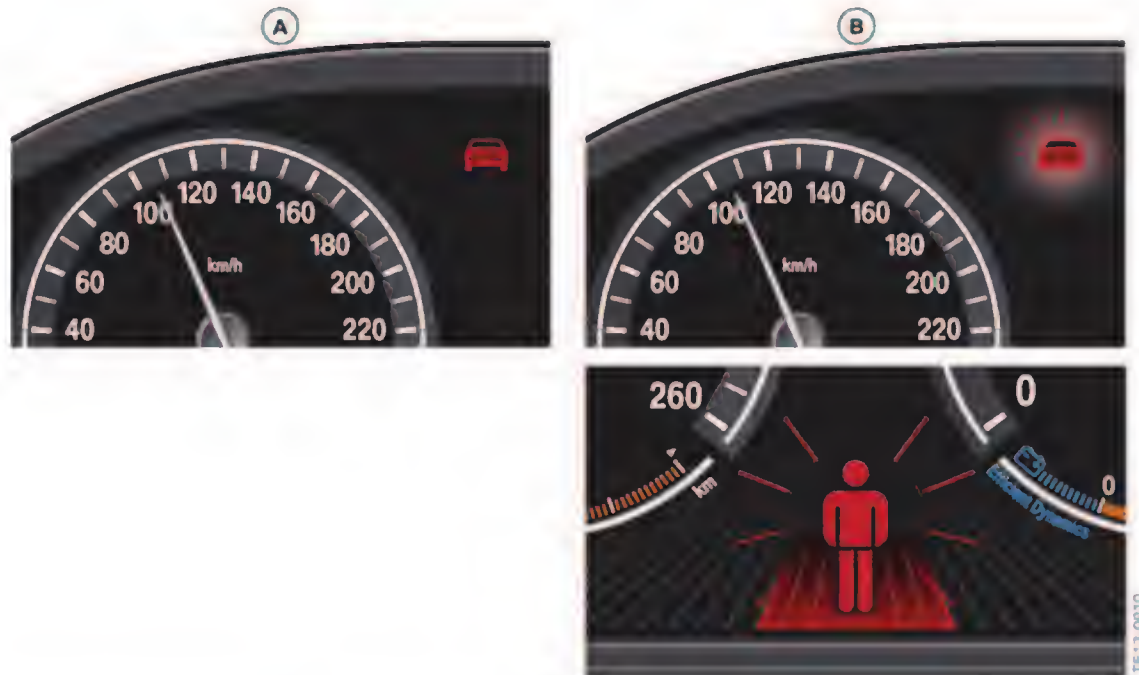

BMW 5 Series LCI Collision warning in the instrument cluster



BMW 5 Series LCI Collision warning in the Head-Up Display

Index	Explanation
A	Stage 1: Early warning, vehicle in red
B	Stage 2: Acute warning, flashing vehicle or pedestrian in red and acoustic warning signal

5 Series LCI

6. Driver Assistance Systems

Early warning

The early warning is only executed for vehicles and not for pedestrians. The early warning is issued, for example, in the event of an imminent danger of collision on account of a high differential speed to the vehicle driving ahead or in the event of a very small distance to the vehicle driving ahead.

The early warning is indicated by a vehicle permanently illuminated in red in the instrument cluster or in the head-up display.

The time of the early warning can be configured in the CID.



The collision warning is dependent on the vehicle's inherent driving speed. The distance calculated for the collision warning is much lower than the minimum distance required by law. It is therefore still the driver's responsibility to maintain the legal minimum distance.

Acute warning

The acute warning can be displayed for vehicles and pedestrians. The acute warning alerts the driver to a potential situation of danger both visually and audibly. The acute warning is issued by the system as late as possible and only if there is an immediate danger of a collision when the vehicle is approaching the vehicle driving ahead at relatively high differential speed or if there is an immediate danger of a collision with a pedestrian. The point at which the acute warning is issued is calculated in such a way that a collision can only be avoided by immediate emergency braking or by an evasive maneuver. The acute warning therefore cannot be deliberately brought about or monitored.

If the vehicle is for example approaching at very low speed the vehicle driving ahead, no acute warning is issued either when the distance to the vehicle ahead is very small. This deliberately brought-about driving situation merely triggers off the early warning. In this way, less sensible and thus more annoying acute warnings are avoided by the system.

The acute warning for vehicles cannot be deactivated separately. Nor can the time of the acute warning be set. If the acute warning is not to be issued, the collision warning front protective function must be deactivated.

An acute warning is indicated to the driver by a red flashing vehicle or person in the instrument cluster. In addition, an acoustic warning signal is sounded.

The acute warning is executed for pedestrians only at speeds between 10 and 60 km/h / 6 and 37 mph. For vehicles the acute warning is executed at speeds above 5 km/h / 5 mph.

Parallel to the warning, the brake system is also prepared to decelerate quicker and heavier. With these measures the driver receives specific support at the same time as the warning to be able to respond effectively.



The acute warning does not relieve the driver of their responsibility to adapt their driving speed and driving style to the road and traffic conditions.

5 Series LCI

6. Driver Assistance Systems



System limitations mean that warnings may under certain circumstances not be issued or are issued too late or without authorization. The driver must therefore always remain alert and observant so that they can actively intervene at any time so as to avoid the risk of an accident.

In towing or tow-starting situations the collision warning system must be deactivated in order to avoid malfunctions.

Brake intervention

If the driver can no longer avoid the accident with his own reactions, an automatic brake intervention is introduced as a final step. The brake intervention is applied initially at a **brake force of 4 m/s²** and can avoid collisions up to a differential speed of roughly **18 km/h / 11 mph**. At higher differential speeds the impact speed is reduced by a smaller amount. As well as the driver being able to support the effect of the system, he also has the option at any time to oversteer the automatic emergency braking by a steering wheel movement or by accelerating, thus cancelling it.

The brake intervention of the collision warning can be overridden by the following actions:

- Sharp acceleration of the vehicle by the driver
- Introduction of an avoidance maneuver by the driver
- Strong brake intervention by the driver

The brake intervention is executed for pedestrians in the speed range between 10 and 60 km/h / 6 and 37 mph and for vehicles in the speed range between 5 and 60 km/h / 3 and 37 mph.

6.5.4. Timescale of collision warning with city braking function

The timescale of the warnings and the braking is shown in the following graphic. There is no brake intervention if an avoidance by the driver is recognized.

5 Series LCI

6. Driver Assistance Systems

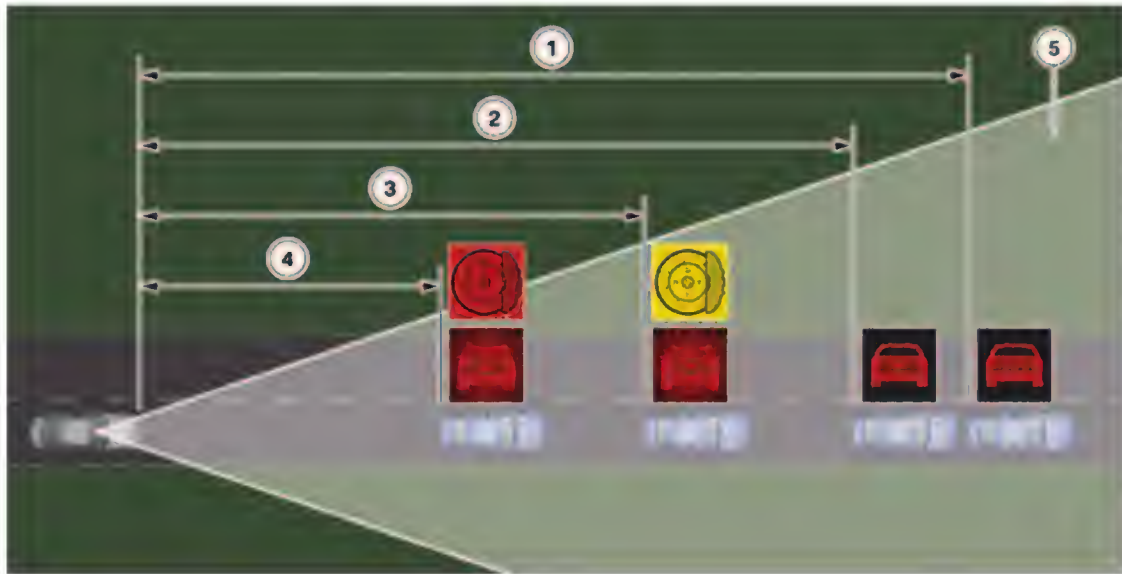

Timescale of camera-based collision warning

Index	Explanation
1	Collision warning (early)
2	Collision warning (late)
3	Acute warning (acoustic warning signal, brake system is prepared and brake assistants adapted)
4	Braking at 4 m/s ² is introduced (city braking function only in the range between 5 and 60 km/h / 3 and 37 mph)
5	Detection range of KAFAS camera

6.5.5. System limits



System limitations mean that warnings may, under certain circumstances, not be issued or are issued too late or without authorization. The driver must therefore always remain alert and observant so that they can actively intervene at any time so as to avoid the risk of an accident.

5 Series LCI

6. Driver Assistance Systems



Range of detection

The collision warning has a limited capacity for detection.

This means that warnings sometime may not be issued or may be issued late.

The following vehicles may possibly not be detected:

- A vehicle travelling at slow speed when approaching at high speed
- Vehicles that cut in suddenly or are heavily decelerating
- Vehicles with an unusual rear view or with poorly visible rear lights
- Partially concealed vehicles
- Two-wheeled vehicles travelling ahead

6.5.6. Functional limitations

The function of the KAFAS camera and thus also the function of the corresponding assist systems may be impaired for example in the following situations:

- Heavy fog, rain or snow
- Strong light in the camera lens
- If the field of view of the KAFAS camera or the windscreen is dirty or concealed
- On sharp bends
- Up to 10 seconds after an engine start via the START-STOP button
- During the calibration process of the KAFAS camera immediately after vehicle delivery or a camera change



Example of functional limitation by back-light

5 Series LCI

6. Driver Assistance Systems

The pedestrian warning with city braking function is available to the driver only under the following conditions:

- Speed between 6 and 37 mph (10 and 60 km/h)
- Adequate daylight
- For pedestrians taller than 31.5 inches (80 cm) standing upright



System and functional limitations mean that warnings and bans may under certain circumstances not be issued or are issued too late or without authorization. The driver must therefore always remain alert and observant so that they can actively intervene at any time so as to avoid the risk of an accident.



6.5.7. Check Control messages

If the system fails, the corresponding Check Control messages are output.

Check Control message	Symbol	Supplementary information	Cause
Pedestrian warning failed.		Pedestrian warning failed. Have vehicle checked by your BMW Service authorised workshop.	KAFAS camera or control unit defective or failed.
Pedestrian warning restricted.		Pedestrian warning restricted during the day. No brake intervention is executed upon acute pedestrian warning. Warnings are still executed visually and audibly. Have vehicle checked by your BMW Service authorised workshop.	Brake function has failed. Full extent of function is no longer available.
Pedestrian warning. Check field of view.		Pedestrian warning during the day. Check field of view of the front camera. Restricted functionality of pedestrian warning. See Owner's Handbook.	Field of view of camera restricted, e.g. by dirt contamination, back-light or weather conditions.

5 Series LCI

6. Driver Assistance Systems

Check Control message	Symbol	Supplementary information	Cause
Collision warning deactivated!		Collision warning deactivated. You have deactivated the collision warning. No warning is output when driving too close.	Collision warning was deactivated by driver.
Collision warning failed.		Collision warning failed. No warning is output when driving too close. Have vehicle checked by your BMW Service authorised workshop.	KAFAS camera or control unit defective or failed.
Collision warning deactivated.		Collision warning deactivated. No warning is output when driving too close. Person recognition restricted. Check sensor field of view and clean sensor if required, see operating instructions.	Field of view of camera restricted, e.g. by dirt contamination, back-light or weather conditions.

6.6. Collision warning with braking function (option 5AT)

The collision warning with braking function is a supplement to Active Cruise Control with Stop & Go (ACC Stop & Go) and uses its sensor system and system components. It is an integral part of the optional equipment **ACC Stop and Go + Active Driving Assistant (option 5AT)**.

The collision warning with braking function warns the driver of a possible danger of collision and provides assistance in an emergency in the form of an automatic brake intervention.

In the BMW 5 Series LCI the generation of the collision warning with braking function introduced with the F01/F02 LCI is used, which permits higher braking deceleration thanks to the fusion of radar and image data.

Similar to the camera-based collision warning, in the BMW 5 Series LCI the collision warning with braking function is extended with the function pedestrian warning with city braking function. The collision warning with city braking function is already covered by the main functions of the collision warning with braking function. **The identification of pedestrians (for the collision warning with braking function) is also achieved here by using only the image data of the KAFAS camera.**

5 Series LCI

6. Driver Assistance Systems

6.6.1. Functional principle

The system warns of a possible collision from a speed of around 5 km/h / 3 mph initially with an early warning and then if the danger persists, with an acute warning.

The collision warning is also available when cruise control is deactivated.

Stationary and moving vehicles are taken into consideration here.

In addition to the warnings, the vehicle's brakes are prepared for emergency braking and the activation thresholds of the brake assistant is decreased. In an emergency an automatic brake intervention is performed by the system.

In the event of a deliberate forward collision with a vehicle, the system sensitivity is reduced in order to avoid unwarranted and thus annoying warnings.

Pedestrian warning with city braking function

The pedestrian warning with city braking function is designed to prevent possible collisions with pedestrians in urban areas or lessen the results of an accident. In sufficient daylight the system identifies a possible collision with a pedestrian, warns the driver early and introduces emergency braking in the event of an unavoidable collision by the driver in order to reduce the vehicle kinetic energy.

The system provides a warning against a collision with pedestrians from a speed of roughly **10 km/h / 6 mph** up to a maximum speed of **60 km/h / 37 mph**.

The KAFAS camera records the scenery ahead of the vehicle and uses image processing to detect pedestrians in the field of view. An acute warning is output in critical situations on the basis of the calculated positions, distances and the movement of the identified pedestrians. An early warning is not available for the pedestrian warning with city braking function. With an acute warning the vehicle is decelerated at a maximum rate of **4 m/s²**.

At night the pedestrian warning with city braking function in vehicles with BMW Night Vision is automatically switched off and replaced with the pedestrian warning of the BMW Night Vision. At night only a warning function for pedestrians is available in vehicles with BMW Night Vision. There is no braking function. The change of the systems is not pointed out to the driver.

In vehicles without BMW Night Vision the pedestrian warning with city braking function also remains activated at night. However, the identification of pedestrians using the KAFAS camera is severely restricted at night due to the lighting conditions.

6.6.2. Operation

The collision warning and pedestrian warning are switched on and off via the Intelligent Safety button.

5 Series LCI

6. Driver Assistance Systems



BMW 5 Series LCI Intelligent Safety button

Index	Explanation
1	Intelligent Safety

The new Intelligent Safety button replaces the previous button for the collision warning with braking function. Using the Intelligent Safety button the following front protection functions of the collision warning, with braking function and BMW Night Vision systems, can be activated and deactivated depending on the equipment in the vehicle.

- Collision warning
- Pedestrian warning (pedestrian warning with city braking function and BMW Night Vision)

A menu appears in the CID when the button is pressed in which the functions can be individually switched on or off. The LED above the button illuminates as soon as at least one of the functions is switched on. The front protection functions are automatically switched on each time the engine is started via the START-STOP button.

From the information pages on Intelligent Safety you can also get to the menus for adjusting the warning time of the collision warning with braking function.



BMW 5 Series LCI Displays on the central information display

When the collision warning is activated the driver can set the time of the early warning in three stages. The setting of the time of the early warning is saved for the current driver profile.

6.6.3. Warning and braking function

The function is a camera- and radar-based assist system and can avoid accidents with pedestrians, vehicles or can reduce the results of an accident in the event of a collision. The operating principle is based on an identification and warning algorithm. The image processing identifies pedestrians and vehicles in the detection range of the camera. Detection of vehicles is also performed via the radar sensor. Using a motion prediction a risk of a collision is calculated taking into consideration the vehicle movement. If a situation is evaluated as critical by the warning algorithm, a warning is output and braking executed based on a multistage warning concept. The warnings and brake interventions are different for pedestrians and vehicles.

5 Series LCI

6. Driver Assistance Systems

Displays

The warning function appears in the instrument cluster or in the head-up display.



BMW 5 Series LCI Collision warning in the instrument cluster



BMW 5 Series LCI Collision warning in the Head-Up Display

Index	Explanation
A	Stage 1: Early warning, vehicle in red
B	Stage 2: Acute warning, flashing vehicle or pedestrian in red and acoustic warning signal

5 Series LCI

6. Driver Assistance Systems

Early warning

The early warning is only executed for vehicles and not for pedestrians. The early warning is issued, for example, in the event of an imminent danger of collision on account of a high differential speed to the vehicle driving ahead and in the event of a very small distance to the vehicle driving ahead or stationary vehicle.

The early warning is indicated by a vehicle permanently illuminated in red in the instrument cluster or in the head-up display.

The time of the early warning can be configured in the CID.

Acute warning

The acute warning is executed for vehicles and pedestrians. The acute warning alerts the driver to a potential situation of danger both visually and audibly. The acute warning is issued by the system as late as possible and only if there is an immediate danger of a collision when the vehicle is approaching the vehicle driving ahead at relatively high differential speed or if there is an immediate danger of a collision with a pedestrian. The point at which the acute warning is issued, is calculated in such a way that a collision can only be avoided by immediate emergency braking or by an evasive maneuver. The acute warning; therefore, cannot be deliberately brought about or monitored.

If the vehicle is for example approaching at very low speed the vehicle driving ahead or a person, no acute warning is issued when the distance is very small. This deliberately brought-about driving situation merely triggers off the early warning. In this way, less sensible and thus more annoying acute warnings are avoided by the system.

The acute warning cannot be deactivated. Nor can the time of the acute warning be set. If the acute warning is not to be issued, the collision warning front protective function must be deactivated.

An acute warning is indicated to the driver by a red flashing vehicle or person in the instrument cluster. In addition, an acoustic warning signal is sounded.

The acute warning is executed for pedestrians only at speeds between 10 and 60 km/h / 6 and 37 mph. For vehicles, the acute warning is displayed at speeds above 5 km/h / 3 mph.

Parallel to the warning, the brake system is also prepared to decelerate quicker and heavier. With these measures the driver receives specific support at the same time as the warning to be able to respond effectively.



The acute warning does not relieve the driver of their responsibility to adapt their driving speed and driving style to the road and traffic conditions and to maintain the prescribed safety distance.



System limitations mean that warnings may under certain circumstances not be issued or are issued too late or without authorization. The driver must therefore always remain alert and observant so that they can actively intervene at any time so as to avoid the risk of an accident.

5 Series LCI

6. Driver Assistance Systems

Brake intervention

If the driver can no longer avoid the accident with his own reactions, an automatic brake intervention is introduced as a final step. Brake intervention is restricted to approx. 3 seconds and must end when the vehicle has been decelerated by around 50 km/h / 31 mph. This avoids additional dangers for the following traffic.

In the lower speed range to approx. 50 km/h / 31 mph brake intervention for vehicles is applied initially at a brake force of roughly 5 m/s². When the target object is verified by the camera data, brake intervention is applied after around 0.5 seconds at max. 8 m/s². The vehicle can therefore be braked in the lower speed range to a standstill.

At a driving speed in excess of 50 km/h / 31 mph brake intervention for vehicles is applied initially at a brake force of roughly 4 m/s². When the target object is verified by the camera data, brake intervention is applied after around 0.5 second at max. 6 m/s².

At a driving speed in excess of 210 km/h / 130 mph the speed reduction is limited to 10 km/h / 6 mph.

In the speed range from 10 km/h to 60 km/h / 6 mph to 37 mph brake intervention for pedestrians is applied at a brake force of roughly 4 m/s².

Brake intervention is also applied when the driver fails to press the brake pedal sufficiently.

Brake intervention is applied only when Dynamic Stability Control (DSC) is switched on.

The brake intervention of the collision warning can be oversteered by the following actions:

- Sharp acceleration of the vehicle by the driver
- Introduction of an avoidance maneuver by the driver
- Strong brake intervention by the driver

In towing or tow-starting situations the collision warning with braking function must be deactivated in order to avoid malfunctions.

The braking function is deactivated when Dynamic Stability Control (DSC) or Dynamic Traction Control (DTC) is deactivated.

If the KAFAS camera fails, brake intervention for vehicles is applied only at a brake force of max. 4 m/s² and solely in response to detected moving or stopped vehicles. In the case of vehicles which were already stationary when they entered the radar sensor's detection range, there is no braking. If the radar sensor fails, the collision warning with braking function is deactivated. In both cases the driver is informed of the failure by means of a display in the instrument cluster and a Check Control message.

5 Series LCI

6. Driver Assistance Systems

6.6.4. History

The collision warning with braking function, formerly the adaptive brake assistant, was introduced for the first time in 2007 with the E60 LCI. The table below sets out the various development stages, their features and their initial implementation in BMW models.

Features	Adaptive brake assistant	Adaptive brake assistant with warning function	Collision warning with braking function	Collision warning with braking function Latest generation
Initial implementation	03/2007 E60 LCI	08/2009 F01	01/2010 F10	07/2012 F01/F02 LCI
Preparation of brake system	X	X	X	X
Adaptation of brake assistant	X	X	X	X
Early and acute warnings				
in resp. to moving/ stopped targets		X	X	X
in resp. to stationary targets			X	X
Braking				
in resp. to moving/ stopped targets			X	X
in resp. to stationary targets				X
at max. 3 m/s ²			X	
at v ≤ 50 km/h, 31 mph at max. 8 m/s ² two-stage to a standstill				X
at v > 50 km/h, 31 mph at max. 6 m/s ² two-stage				X

5 Series LCI

6. Driver Assistance Systems

6.6.5. Comparison to the camera-based collision warning

The following table provides an overview of the differences between the two systems:

	Camera-based collision warning	Collision warning with braking function
Collision warning (vehicles)		
Sensors	KAFAS camera	Radar sensor and KAFAS camera
Speed range for braking function	3–37 mph (5-60 km/h)	from 3 mph (5 km/h)
Maximum braking deceleration	4 m/s ²	8 m/s ²
Pedestrian warning		
Sensors	KAFAS camera	KAFAS camera
Speed range for braking function	6–37 mph (10-60 km/h)	6–37 mph (10-60 km/h)
Maximum braking deceleration	4 m/s ²	4 m/s ²

6.7. Speed Limit Info

The optional equipment Speed Limit Info (8TH) is referred to in the following section as Road Sign Recognition for short. Current speed limits and bans on passing/overtaking are shown in the instrument cluster or in the head-up display. In this way, Road Sign Recognition helps the driver to adhere to and not to exceed the maximum speed limit.

8TH Speed Limit Information is only available in conjunction with the navigation system (standard) and it is part of the optional ZDB Driver Assistance Package.



The responsibility for the vehicle and for the speed that is adopted rests exclusively with the driver.

The control unit for the Road Sign Recognition function is the KAFAS control unit.

The display of the speed limit signs is based on the evaluation of data from the navigation system and the evaluation of image data recorded by the KAFAS video camera.

The maximum allowable speed of the road currently driven is displayed in the instrument cluster and in the head-up display.

The KAFAS uses the video camera to monitor the road signs at the side of the road and takes into account the information from the navigation system (609). Thus, for example in some areas, the applicable maximum speed is displayed without there being actual recognizable road signs stipulating the speed.

5 Series LCI

6. Driver Assistance Systems



Speed limit information displayed on the HUD (F30 graphic shown)



Speed limit information displayed on the instrument cluster (F30 graphic shown)

6.7.1. System limits

The system has a detection rate of around 90 to 95%.

Road signs for speed limits which do not conform to the legal standards, especially those which do not have square borders, are not always recognized. The same applies to road signs which are fully or partially concealed by stickers, dirt or vegetation.

Long distances to the road sign, high driving speeds and poor weather conditions, particularly at night, make it more difficult for the system to recognize road signs reliably.

The data in the navigation map must be up to date in order for the current speed limit to be correctly displayed. If the current place has not yet been incorporated for navigation purposes, for example when driving in development areas, on new roads or on roads where the routing has been changed, a recognized road sign for speed limits can only be displayed for the next 500 m (547 yds).

5 Series LCI

6. Driver Assistance Systems

Supplementary sign recognition

The system can only recognize signs that are included in its database. Text references to supplementary signs cannot be read or interpreted. Before speed limits with limiting validity are displayed, the system scans further information from the vehicle electrical system.

The system can't read text, it can only recognize a sign that is included in the "sign database" – therefore the system was programmed extensively in 48 US states + western/eastern Canada therefore all speed limit signs (10-80 mph + signs as e.g. "Trucks", "Trailers", "School", "Construction area") are normally (when conditions allow) recognized by the camera.

The trailer signal for vehicles in towing mode is not evaluated for the display of speed limits, as the speed limits for vehicles with trailers differ from country to country and are dependent on the trailer type.

Supplementary signs are not recognized. The speed limit is then displayed as currently valid without the supplementary sign being interpreted.

Road signs on parallel, branching-off or merging roads and on exits

Parallel roads are not recognized neither with the KAFAS video camera nor with the aid of the navigation map. Signs posted there can be recognized and displayed as speed limits for the road currently being driven.

Speed limits for branching-off or merging roads are usually also adopted and displayed for the road currently being driven.

Speed limits on highway exits with or without an arrow as a supplementary sign are usually correctly evaluated and suppressed in the displayed when the exit is driven past. This is only the case if the data in the navigation map is up to date.

In the case of overhead highway signs with different, lane-specific speed limits, the speed limit nearest to the lane the vehicle is driving in is displayed. The display is not modified after a later lane change.

Information signs in the road sign surroundings

Information signs with speed limits at border crossings with references to the different legal maximum speeds for ordinary roads and highways, can be mistakenly recognized as currently valid and displayed. The same applies to information signs set out only in different colors, e.g. for minimum or recommended speeds.

Stickers on vehicles

Stickers showing a speed limit on vehicles driving ahead or on overtaken vehicles, e.g. on trucks, buses, trailers and construction machinery, can be mistakenly recognized as the currently valid speed limit and displayed.

Town/city limits

If the town/city limits sign is not clearly recognized and the data in the navigation map are not up to date, the speed limit at town/city limits may be incorrectly displayed.

5 Series LCI

6. Driver Assistance Systems

Legal changes

If maximum speeds prescribed by law are changed, these are only available after a navigation software update. The original, but no longer valid speed limits are displayed until the update is issued.



The system can only currently detect speed limit signs and no other traffic signs.

This system cannot replace the driver's personal assessment of the road and traffic situation. Speed Limit Information supports the driver but does not intend to replace the human eye.

6.8. High-beam assistant

In vehicles without Adaptive LED headlight (option 552) the function of the high-beam assistant (option 5AC) remains unchanged at two stages. The high-beam headlight is automatically switched on and off.

For further information on the high-beam assistant in this case, please refer to the Training Reference Manual "ST811 F01 Complete vehicle."



The high-beam assistant cannot replace a personal decision on the use of the high-beam headlight. In some situations, manual dipping is required as otherwise there is a safety risk.

6.9. ACC Stop & Go

Active Cruise Control with Stop & Go function (ACC Stop & Go) is an integral part of the optional equipment ACC Stop & Go + Active Driving Assistant (option 5AT) and has improved functionality.

ACC Stop & Go + Active Driving Assistant adjusts a driver-specified set speed and, if required by the traffic situation, also the preselected following distance automatically to the vehicle driving ahead. Passenger cars, trucks and motorcycles are detected as vehicles. The scope of application ranges from high speeds down to a stop. Depending on the stationary time, driving off from a standstill is performed automatically or in response to a prompt by the driver.

ACC Stop & Go + Active Driving Assistant in the BMW 5 Series LCI detects not only slowly stopping, but also stationary vehicles, and can react to these. The detection of stationary vehicles is a unique feature.

The reaction to transverse movements has also been improved. This enables the system to react more swiftly to vehicles that are veering in and out and turning.

The extended application range is achieved by connecting the KAFAS camera installed in the vehicle to the system. As well as the radar data, the image data from the camera is now evaluated in ACC Stop & Go. This fusion of image and radar data facilitates the clear identification of lane markings and distinction between stationary vehicles and other immobile objects.

In addition, the adjustment range for the set speed has been increased from 180 km/h to 210 km/h / 110 mph to 130 mph.

5 Series LCI

6. Driver Assistance Systems

The acceleration behavior of ACC Stop & Go is adapted for ECO PRO mode. ACC Stop & Go accelerates the vehicle in ECO PRO mode more smoothly for optimized consumption. The ECO PRO instructions regarding the accelerator pedal position are suppressed when ACC Stop & Go is activated.

6.9.1. Introduction

ACC Stop & Go + Active Driving Assistant offers the driver optimum support not only in flowing traffic, but also in traffic jam situations.

The scope of application of ACC Stop & Go ranges from high speeds down to a stop. The distance and the speed are automatically adjusted in this range.

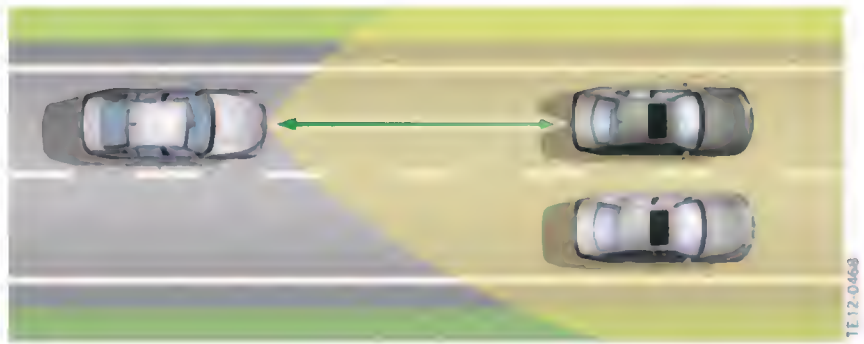

BMW 5 Series LCI Active cruise control

ACC Stop & Go controls the speed if there is no vehicle driving directly ahead and automatically switches to distance control if the radar sensor detects a slower vehicle in its lane.

A 77 GHz radar sensor in the system can identify vehicles up to 200 m ahead; this sensor can operate independently of weather conditions. Thanks to the radar sensor's improved detection capability and the adjustment with the image data from the KAFAS camera, even vehicles in the neighboring lanes are detected. If these vehicles drive into the subject vehicle's own lane, ACC Stop & Go adapts the speed to vehicles veering in or driving ahead. Consequently a time interval selected by the driver is maintained constant.

5 Series LCI

6. Driver Assistance Systems



BMW 5 Series LCI Schematic diagram of monitoring ranges

Index	Explanation
a	Close range
b	Long-distance range
1	Detection range of KAFAS camera
2	Detection range of radar sensor

The vision cone of the radar sensor is up to 60 m wider in the close range than the vision cone in the long-distance range. This provides for wider lane coverage. Within this range the radar data or detected objects are verified with the image data from the KAFAS camera.

The KAFAS control unit can detect transverse movements better, assign lanes and clearly identify vehicles. In this way, vehicles veering in and out at close range can be detected earlier and more quickly. The fusion of radar and video data also facilitates the clear identification of stationary vehicles.

The system's Stop & Go function brings the vehicle to a complete standstill if necessary. If the vehicle ahead starts a journey again after a standstill, information is output to the driver. To drive off again, the driver must acknowledge this information. Only if the duration of the standstill is very short does the starting process take place fully automatically by ACC Stop & Go.

In this way, ACC Stop & Go supports the driver not only in flowing traffic, but also in traffic jam situations, both on multiple-lane highways and ordinary roads and on urban arterial and ring roads.

5 Series LCI

6. Driver Assistance Systems

Further consideration should be given here to the following areas of the assist system ACC Stop & Go:

- System components
- Information from the vehicle environment
- Control functions
- Operation and display
- Behavior when driver intends to exit
- Monitoring functions

5 Series LCI

6. Driver Assistance Systems

6.9.2. System components

System wiring diagram

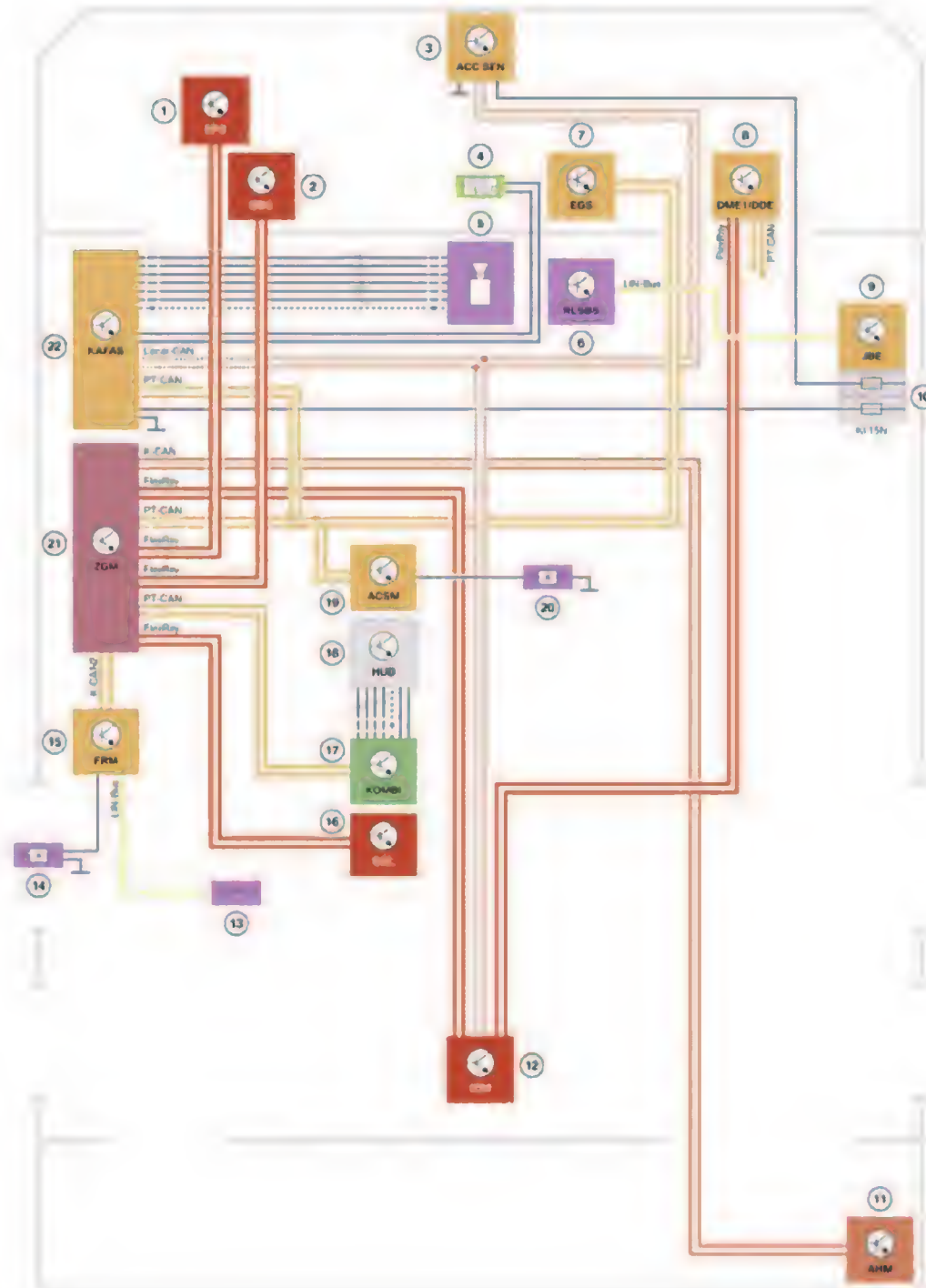

System wiring diagram for ACC Stop & Go

TE 12-1036

5 Series LCI

6. Driver Assistance Systems

Index	Explanation
1	Electronic Power Steering (electromechanical power steering) (EPS)
2	Dynamic Stability Control (DSC)
3	Radar Sensor for ACC Stop & Go
4	Heating KAFAS camera
5	KAFAS camera
6	Rain-Light-Solar-Condensation Sensor (RLSBS)
7	Electronic Transmission Control (EGS)
8	Digital Motor Electronics (DME) or Digital Diesel Electronics (DDE)
9	Junction Box Electronics (JBE)
10	Junction Box for the Power Distribution Box
11	Trailer Module (AHM) (not US)
12	Integrated Chassis Management (ICM)
13	Driver Assistance System Operating Facility
14	Door Contact Driver's Door
15	Footwell Module (FRM)
16	Steering Column Switch Cluster (SZL)
17	Instrument Panel (KOMBI)
18	Head-Up Display (HUD)
19	Crash Safety Module (ACSM)
20	Seat Belt Buckle Contact, Driver
21	Central Gateway Module (ZGM)
22	Camera-Based Driver Support Systems (KAFAS)

Radar sensor

The radar sensor sends out bundled electromagnetic waves. The echoes reflected by objects are received and evaluated by the radar sensor. Information on objects located in front of the radar sensor can be achieved in this way. This information includes size, distance and the speed derived therefrom.

Similar to the F01/F02 LCI, the radar sensor receives additional information from the KAFAS control unit via its own sensor bus. This information is lane information, information on transverse movements and information on vehicle identification. The information supports the radar sensor in detecting and evaluating objects and facilitates clear vehicle identification. This video data is required for the reaction to stationary vehicles.

5 Series LCI

6. Driver Assistance Systems



BMW 5 Series LCI Radar sensor for ACC Stop & Go

The radar sensor is located behind a removable grille on the front bumper.

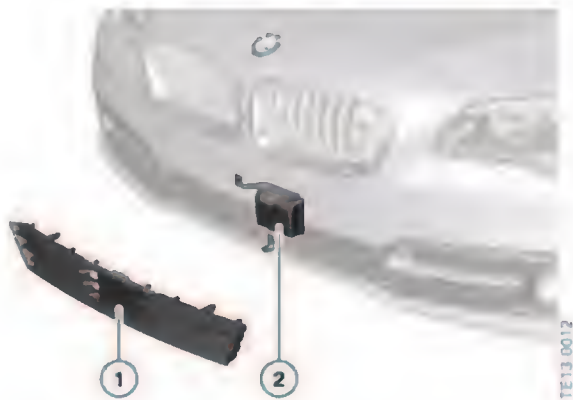

BMW 5 Series LCI Installation location of radar sensor

Index	Explanation
1	Removable grille
2	Radar sensor for ACC Stop & Go

5 Series LCI

6. Driver Assistance Systems

KAFAS camera and control unit

The KAFAS control unit clearly detects vehicles when their rear ends are recorded by the camera. The KAFAS control unit also supplies lane information and thus helps the radar sensor to determine vehicle position and movement more quickly. The data is transmitted via the sensor bus to the radar sensor.

Integrated Chassis Management ICM control unit

For a detailed description of Integrated Chassis Management (ICM), please refer to the Training Reference Manual "ST811 F01 Complete Vehicle". The following text provides a brief overview and addresses the particulars connected with the topics presented here.

The ICM in the BMW 5 Series LCI calculates the control functions, sensor data and vehicle values used to influence longitudinal and transverse dynamics. Also integrated in ICM are micro-mechanical sensors which supply driving dynamics signals.

Two different ICM versions are used in the BMW 5 Series LCI. A basic version for vehicles without ACC Stop & Go + Active Driving Assistant and a high version for vehicles with ACC Stop & Go + Active Driving Assistant.

5 Series LCI

7. Entertainment and Communication

7.1. Headunits

The following headunit is available for the BMW 5 Series LCI:

Standard equipment	Headunit	CID	Controller	Navigation
Professional navigation	Headunit High	10.2"	7-button with touchpad	Yes

More information on the Headunit High can be found in the Training Reference Manual "ST1211 Headunit High".

7.1.1. New features of Headunit High

A further developed version of the Headunit High is used in the BMW 5 Series LCI. The following new functions are available:

- With the BMW 5 Series LCI it is possible to import and export a Personal Profile using the BMW Connected app. This gives the user a simple option of transporting and updating his Personal Profile in several BMW vehicles without having to use a USB stick.
- With the audio playback via Bluetooth one can navigate through the directory structure the same way as for the audio playback via USB. The Bluetooth profile AVRCP in version 1.4 is used here.
- With the volume control the current volume is displayed as a bar in the central information display. The labelling of the volume bars clarifies which source is changed in the volume (for example entertainment, call or announcement of navigation system).
- SDARS radio was extended with a timeshift function. The current playback is recorded for up to 45 minutes. For example, the user can rewind to play a news broadcast again.



New features of Headunit High

5 Series LCI

7. Entertainment and Communication

Index	Explanation
1	Volume bars with labelling "Entertainment"
2	DAB journal function (not US)
3	SDARS timeshift function

The following new features in the navigation area are introduced for the BMW 5 Series LCI:

In the navigation system areas can be marked which are avoided during the route planning. For example, an area blocked for an extended period due to construction work can be excluded from the route planning.



Route planning

Index	Explanation
1	Define areas to be avoided
2	Rectangle of area to be avoided
3	Storage process of area to be avoided

The destination input can now also be input using GPS coordinates.

5 Series LCI

7. Entertainment and Communication



Destination input using GPS coordinates

Index	Explanation
1	Destination input using GPS coordinates
2	Input screen for GPS coordinates

The Special destinations area was also improved. For instance, it is now possible to select historical monuments as special destinations. Highway rest stops are now also offered as a possible destination directly with the message of the alertness assistant.



Special destinations

Index	Explanation
1	Message of alertness assistant with link to special destinations
2	Special destinations: Highway rest stops
3	Special destinations: Historical monuments

5 Series LCI

7. Entertainment and Communication

The constant further development of the Headunit High meant it was necessary to divide the hard disk. Take a look at the following graphic to see the division of the hard disk with the introduction of the BMW 5 Series LCI vehicles.

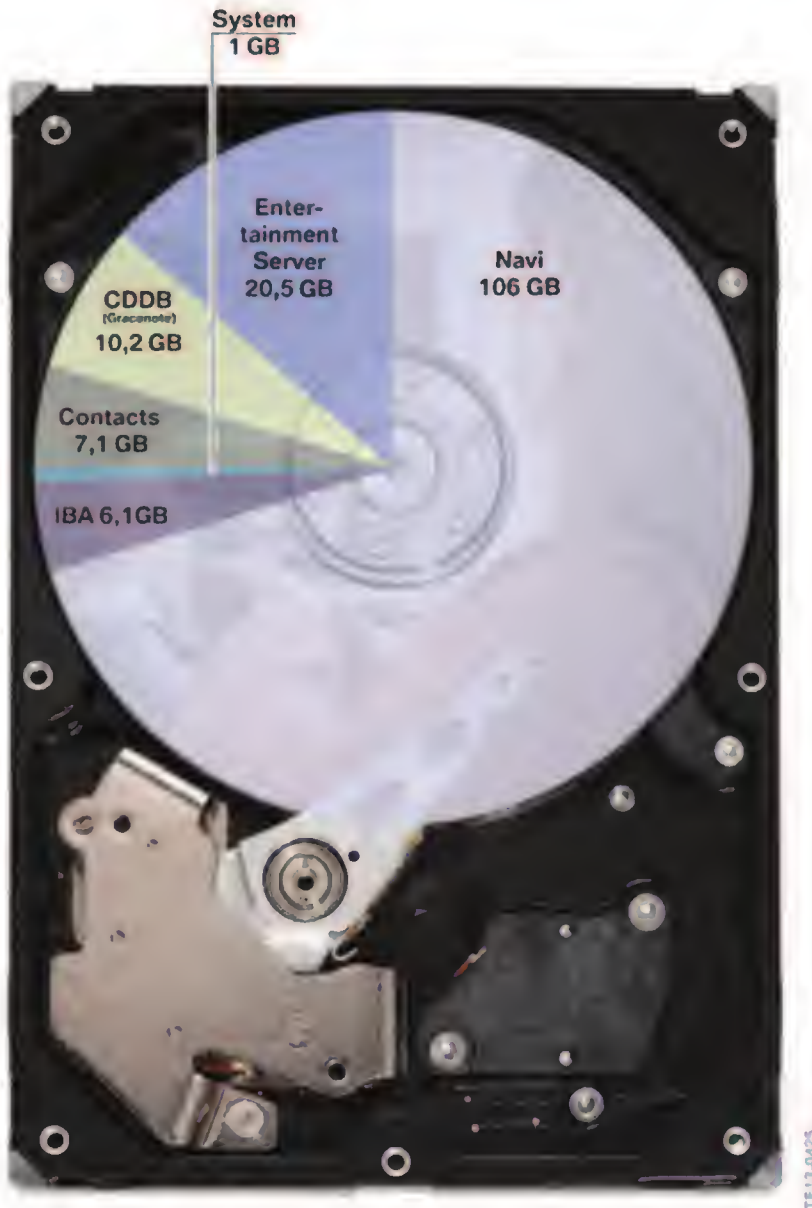

Division of the hard disk of Headunit High

5 Series LCI

7. Entertainment and Communication

7.1.2. Deletion of internal yaw sensor, Headunit High

With the BMW 5 Series LCI the yaw sensor integrated in the Headunit High is deleted. The information on the vehicle yaw is made available to the headunit by the ICM control unit.

7.2. Speaker systems

The speaker systems in the BMW 5 Series LCI are available in four specification levels:

Name	Optional equipment	System	Speaker
HiFi Loudspeaker System	Standard	HiFi system	12
Harman Kardon Surround Sound System	Option 688	Top HiFi system	16
Bang & Olufsen High-End Surround Sound System	Option 6F2	Top HiFi system	16

7.3. Rear seat entertainment system



Rear passenger compartment entertainment

5 Series LCI

7. Entertainment and Communication

There is only one version of the rear seat entertainment system available in the BMW 5 Series LCI. The rear seat entertainment system (option 6FH) in the BMW 5 Series LCI is operated using a remote control. The activation of the freestanding rear displays adopted from the F01 LCI is done via APIX (Automotive Pixel Link).

More information on the rear seat entertainment system is available in the Training Reference Manual "ST1211 Headunit High".

7.4. ConnectedDrive realignment

As with all 2014 MY BMW vehicles, the 5 Series LCI standard equipment structure of the telephone functions and the telematics services of ConnectedDrive have been updated.



The following information applies to all 2014 MY BMW vehicles.

The option codes for the individual services have been changed and the features reorganized as follows.

Name of optional equipment (previous)	Optional equipment code (up to 03/2013)
Hands-free Bluetooth with USB audio interface	Option 6NH
BMW Assist with enhanced Bluetooth and USB	Option 6NL
BMW Apps	Option 6NR
Real Time Traffic Information	Option 6UH
Smartphones Integration (music interface)	Option 6NF

The list of the **new** optional equipment is below:

Name of optional equipment (new)	Optional equipment code (new)
Enhanced USB and Bluetooth plus Smartphone Integration	Option 6NS
BMW Assist eCall (intelligent emergency call)	Option 6AC
BMW Online (ConnectedDrive services)	Option 6AK
BMW TeleServices (only in connection with option 6AC and/or option 6AK)	Option 6AE
Advanced Real Time Traffic Information (ARTTI)	Option 6AM
Remote Services	Option 6AP
Concierge Service (previously BMW Information Service)	Option 6AN
Internet (new optional equipment number)	Option 6AR

The following adaptations have been made to the standard equipment for telephone functions:

- Enhanced USB and Bluetooth plus Smartphone Integration (6NS).

5 Series LCI

7. Entertainment and Communication

The following standard equipment was introduced for the control of telematics services:

- BMW Assist eCall (6AC): 10 years
- BMW TeleServices (6AE): 10 years
- Remote Services (6AP): 10 years
- BMW Online (6AK): 3 years
- Advanced Real Time Traffic Information (6AM)

The following optional equipment can be ordered :

- Concierge Services option 6AN: 3 years, (fee applies)
- Internet option 6AR: 1 year subscription, (fee applies)

	BMW Assist eCall 6AC 10-years	TeleService 6AE 10-years	BMW Online 6AK 10-years	Remote Services 6AP 10-years	BMW Apps 6NR	Advanced Real-Time Traffic Information 6AM 10-years	Concierge 6AN 10-years	Internet 6AR 10-years
X1 Z4	100%	100%	Navigation bundle			N/A	Option/Upsell (only with 609)	N/A
3 Series 4 Series X3	100%	100%	Navigation bundle				Option/Upsell (only with 609)	Upsell (only with 609)
5 Series X5	100%	100%	100%	100%	100%	100%	Option/Upsell	Upsell
6 Series 7 Series	100%	100%	100%	100%	100%	100%	Option/Upsell (standard on 50, 60, M models)	Upsell

ConnectedDrive realignment for 2014 MY vehicles.

For detailed information on the realignment of the telematics services of ConnectedDrive please refer to PKOD.

7.4.1. BMW Assist eCall

The Enhanced Automatic Collision Notification (eCall) function was previously only available in conjunction with the optional equipment "BMW Assist with enhanced Bluetooth and USB" (option 6NL). The feature was thus always in the upper price segment. This is now set to change with the ConnectedDrive realignment.

The BMW Assist eCall (intelligent emergency call) (option 6AC) and BMW TeleServices (option 6AE) are now offered to the customer as standard equipment for 10 years on all BMW 2014 models. These features are activated in conjunction at the vehicle delivery. Unlike before with the optional equipment "BMW Assist with enhanced Bluetooth and USB (option 6NL), the customer does not have to complete an application to be able to use the services.

As described in the chapter "BMW TeleServices up to 03/2013", the necessary hardware is also automatically activated with BMW TeleServices. The function remains identical to the former optional equipment "BMW Assist with enhanced Bluetooth and USB" (option 6NL).

5 Series LCI

7. Entertainment and Communication

Enhanced Automatic Collision Notification key points are:

- In the event of an accident (collision, rollover, etc.), which exceeds the first crash threshold (belt tensioner or active head restraint are activated), the transmission of information is enabled for speedy and specific assistance at the place of the accident.
- Data on the exact position of the vehicle is transmitted via the TCB P-SIM to the BMW Call Center; vehicle identification number, vehicle type and vehicle color and also data collected from airbag sensors in the vehicle.
- Entry of how many people are sitting in the vehicle and which airbags have been deployed. System sensors are used to register the intensity of the crash. Front, rear, side or also multiple collisions, as well as any rollover, depending on the model, can be identified and differentiated from each other.
- Using this data the rescue workers obtain detailed information about the type of collision. An algorithm compiled by BMW with scientific support calculates the risk of injury of the occupants in order to be able to duly prepare adequate medical supplies for those involved in the accident.
- The specially trained employees who work in the BMW Call Center (open 24/7) establish telephone contact with the occupants of the vehicle and upon request support them until the arrival of the rescue workers. There is also the option of a telephone conference were the BMW Call Center establishes a direct voice contact between the occupants and the rescue coordination center.
- There is also the option to manually activate the emergency call. For example, for other road users to call for assistance as quickly as possible.



Button for manual activation of the emergency call

5 Series LCI

7. Entertainment and Communication

7.4.2. BMW TeleServices from 03/2013

The BMW TeleServices systems are generally installed in every vehicle with a telematics system from 03/2013. From a technical point of view nothing will change for the BMW TeleServices systems. The change of the number of the optional equipment from 6AA/6AB to 6AE is the main change.

Automatic activation in the pre-delivery check

The activation (provision) of BMW TeleServices and the connected telematics systems within the framework of the **pre-delivery check** is new. Here the activation can be started **automatically**. After a replacement of the headunit or the telephone control unit the activation of the telematics services (BMW Online) is also performed following the control unit programming. The automatic activation of BMW Online is also part of the final activities following programming of the headunit and the telephone control unit. An online connection of the workshop systems to BMW AG is necessary for automatic activation of BMW Online. The automatic activation is only possible with use of the Headunit High and the relevant telematics control unit (TCB).

Manual activation

If online availability cannot be guaranteed during the pre-delivery check, manual activation is still possible. In the case of an active ConnectedDrive contract this is done as before in the menu "ConnectedDrive > Service status > BMW Online".

7.4.3. ConnectedDrive services

The BMW Online ConnectedDrive Services (option 6AK) succeeds BMW Online and BMW Apps (option 6NR). The services are already active for the customer from delivery of the vehicle. A separate application is no longer necessary. The duration of the "Online", "Send to car" and "Weather in navigation" services is three years from date of purchase. The duration for Apps is unlimited. Free registration in the ConnectedDrive portal is required to use personalized services. BMW Online ConnectedDrive Services (option 6AK) is standard equipment on the higher end vehicles like the 5 Series, 6 Series, 7 Series and X5/X6 models. It is offered as a Navigation bundle in all other vehicles (X1, X3, 3 Series and 4 Series)

The following is included in the ConnectedDrive Services package:

- BMW Online with News RSS Feeds, Office and application programs (Wiki[®] Local, etc.)
- BMW Send to car (Google[®] Send to car)
- Weather in the navigation map
- BMW Apps (without video and plug-in function; Navigation Professional (option 609) remain a prerequisite)
- Remote Services (option 6AP; My BMW Remote App for iPhone[®] and Android[®])

5 Series LCI

7. Entertainment and Communication



Range of functions of BMW Online ConnectedDrive Services, option 6AK

Index	Explanation
1	BMW Online
2	Send to car
3	Weather in map
4	BMW Apps

The Remote Services (option 6AP; My BMW Remote App for iPhone® and Android®) is included in the BMW Online ConnectedDrive Services package. The Remote Services is standard equipment on the higher end vehicles like the 5 Series, 6 Series, 7 Series and X5/X6 models and is offered as a Navigation bundle in all other vehicles (X1, X3, 3 Series and 4 Series). It is valid for a term of 10 years. ConnectedDrive Service is the prerequisite for subsequent booking of these additional functions.

7.4.4. Additional ConnectedDrive functions

If the BMW Online ConnectedDrive Services (option 6AK) package is in the vehicle, additional functions can be ordered separately from March 2013. The functions were to a large extent elements of BMW Assist that have been re-packaged.

5 Series LCI

7. Entertainment and Communication

Some ConnectedDrive functions which can be ordered include:

- Advanced Real Time Traffic Info (option 6AM)
- Remote Services (option 6AP; My BMW Remote App for iPhone® and Android®)
- Concierge Services (option 6AN; the previous BMW information service)
- Internet (option 6AR) via P-SIM



Additional functions that can be ordered

Index	Explanation
1	Advanced Real Time Traffic Information (ARTTI) (part of BMW Online ConnectedDrive Services (option 6AK))
2	Remote Services (part of BMW Online ConnectedDrive Services (option 6AK))
3	Concierge Services (this feature is now available as an “up sell” option).
4	Internet (this feature is available as an “up sell” option).

These functions can be ordered when placing the order for the vehicle or afterwards directly in the vehicle via access to the ConnectedDrive Portal. The portal is currently under construction. The ordering of additional functions in the vehicle is planned for the second half of 2013.

5 Series LCI

7. Entertainment and Communication

Advanced Real Time Traffic Information

With the navigation option, you'll also get 3 years of ARTTI because the revised system uses an internet feed to give more precise and accurate traffic information. It is important to note however that E Chassis code models cannot get ARTTI because they do not have the new iDrive 4.2 Navigation system (HUH) but they still have RTTI as a source of traffic information.

The optional equipment Advanced Real Time Traffic Information supplies almost real-time traffic information for the BMW navigation system on highways, national roads and, unlike the predecessor system RTTI, also on intercity connections. This information includes precise details on the traffic situation on the current route and on potential detours.

This information is updated every three minutes via data transfer by means of UMTS (3G) of the P-SIM card integrated in the Telematic Communication Box (TCB). Color road markings on the navigation map displayed in the BMW refer to current obstructions.

Concierge Service

The telephone information service of the BMW Call Center offers support in selecting destinations and arranging a trip, can be ordered under the optional equipment Concierge Service (option 6AN). The information service is available seven days a week, 24 hours a day. Detailed information on so-called Points of Interest (e.g. filling stations shown in the navigation system), opening periods and address data are transmitted directly to the vehicle by the BMW Call Center. The driver can then save the address data to the contacts with the touch of a button (saved on the hard disk of the headunit). It is also possible to immediately save the address destination to the destination input of the navigation system.

Concierge and Internet are available on all vehicles as optional "upsell" features but some cars, like the X1 and Z4 require BMW Online to get it. All models will require Navigation to get these option - remember the 6 and 7 come with Navigation standard.

7.4.5. Internet

As of July 2013 production, vehicles equipped with our new Navigation, often referred to as HU-H or iDrive 4.2, will have 3G Internet capabilities and our new TouchPad controller. As with Concierge Service, this feature is available as a separate option on vehicles with option 609 Navigation and there is an additional cost to the customer.

With the optional equipment Internet (option 6AR) the customer has the option to surf the Internet using the control center operating system (CON central information display (CID)) via a data line of the P-SIM card (TCB) permanently installed in the vehicle (i.e. does not use the customer's phone data). It is available on both the front CID display as well as on the Rear Seat Entertainment screens. For safety reasons, "Internet" is not available on the front screen while driving, but is available on the rear screens while driving. Each display is independent of one another so in essence while the rear passenger side is browsing the internet the rear driver side is able to watch a movie.

The CON at the center console assumes the role of a mouse. Also the direct input of Internet addresses or calling up personal favorites lists is also possible using the CON (controller). The transmission of the data is based on the Headunit High in conjunction with the TCB.

The speed of the data transmission is done on the basis of UMTS (3G; HSDPA downstream with maximum 7.2 Mbit/s). This guarantees immediate transmission of the selected Internet pages to the vehicle, a special BMW server ensures optimized display on the screen.

5 Series LCI

7. Entertainment and Communication

The BMW Internet is implemented for the Headunit High with a newly designed browser based on WebKit. WebKit is a free HTML rendering library, whose basic information is used to build a web browser. The browser also includes support for the BMW plug-in functions "Text-to-Speech" and "Speech control". Customers will be able to do online banking, email, or search web pages . It also allows to set a favorite homepage, for example, Google or Yahoo can set as the homepage in the vehicle.

Navigating the internet is made much easier with our new iDrive Touch pad with a touch sensitive interface on the top of the dial, allowing the driver to write on the controller itself. So, instead of scrolling to a letter to spell out a word, you can simply write that letter with your finger on the top of the controller and iDrive will interpret your input. This feature is useful anywhere that a speller wheel is used, such as Navigation, Multimedia Search, Contacts Search, Phone Numbers and so on.

The Internet can only be used for browsing and it is not be able to stream video with Netflix or YouTube.

A Viewer function for documents embedded in emails (PDF, MS Word, MS Excel, MS PowerPoint) is offered as a highlight. The Viewer function is reserved for emails, which are shown in the web browser. This function is not supported for emails which are sent via Bluetooth telephone (MAP).

The following graphic explains the internet connection procedure.



P-SIM Internet

Index	Explanation
Graphic	Internet connection procedure via P-SIM
1	Central information display
2	Data transmission between headunit and TCB
3	Outside vehicle antenna or for the hands-free system with USB interface (option 6NH)

5 Series LCI

7. Entertainment and Communication

Index	Explanation
4	Data line to provider
5b	Data line to BMW server (backend)
6	Firewall or proxy server of BMW backend
7	Data line P-SIM to Internet

Internet is available as an annual subscription for \$100/year and requires the following:

- New navigation system (i.e. iDrive 4.2)
- Option 6AK (“BMW Online”)

Three simple ways of adding or renewing services (i.e. Internet, Concierge, ARTTI):

- Calling BMW Assist at 1-888-333-6118
- Contacting BMW Assist using the “SOS” button in their vehicle
- Creating a new ESA

Customers can add new services and renew expiring services by contacting BMW Assist.

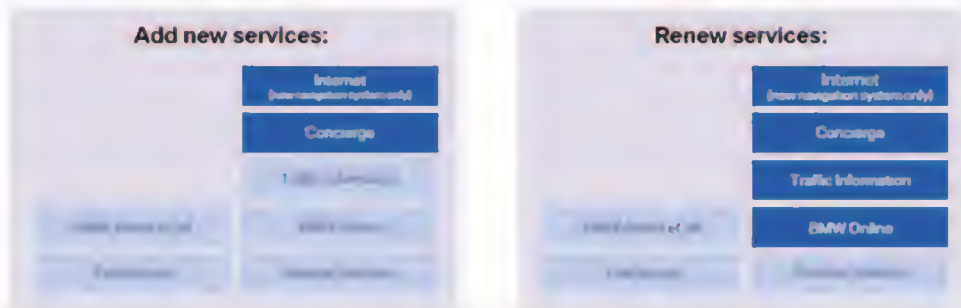
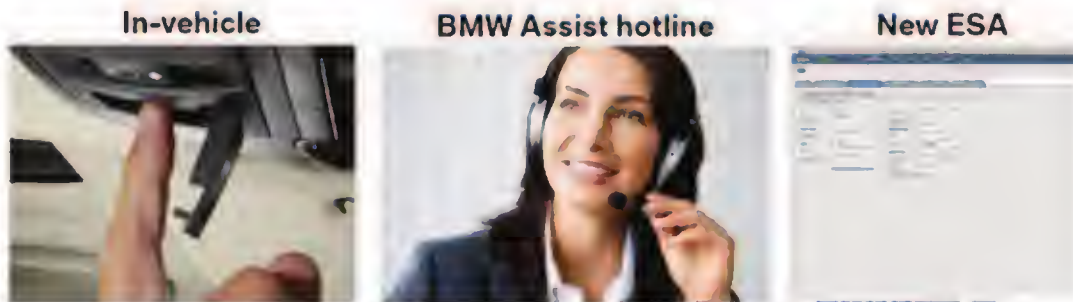

5 Series LCI

7. Entertainment and Communication

7.5. BMW Apps

For the BMW 5 Series LCI the functions of BMW Apps iOS and Android is now standard equipment.



BMW Apps on the smartphone Galaxy S III

The BMW Connected app for Android is being rolled out with a smaller range of functions than the iOS version. The range of functions is gradually being adjusted through regular updates.

The apps for Android are automatically started using a USB upon connection of the smartphone and run in the background. The web radio function is currently not supported for the Android app.

7.6. Audio playback with Android

Audio files on Android smartphones are played differently depending on the connection mode. However, the operating principle and the appearance in the central information display do not differ.

Connection mode	Audio playback using
USB via "external devices"	Headunit High
BMW app for Android ("connection assistant")	Android smartphone

It is not possible to play music via the two connection modes at the same time. In order to access the mass storage device of the Android smartphone, the USB mode must be activated if necessary and the device disconnected from the headunit and connected again via USB.

5 Series LCI

7. Entertainment and Communication



Activation of USB mode for Android app

7.7. Snap-in adapter

By the end of 2013 new snap-in adapters are being introduced for the connection of smartphones to BMW vehicles.



Snap-in adapter

Index	Explanation
1	Snap-in adapter for Samsung smartphones
2	Snap-in adapter for iPhone 5

The new Apple iPhone 5™ features a special connection plug (Lightning). The snap-in adapter for the iPhone 5™ has been custom-designed for this model of phone. The functions of the Music and Media versions have now been brought together for the first time in a Music/Media snap-in adapter for the iPhone 5™. When the iPhone 5™ does not provide an analog audio signal to the Lightning plug, the signal is generated in the Music/Media snap-in adapter. The Connect and Music/Media snap-in adapters have an integrated fan. This is specially designed to protect the temperature-sensitive area of the iPhone 5™ from overheating by circulating air around it. This delays the premature temperature-based switch-off of the device.

The Basic version can be used in all cars with base plate and supports telephone and charging functions. The Music/Media version supports telephone, charging, entertainment and Apps. It is required in cars with SA 6NF that use an analog and digital audio signal. The Connect version supports telephone, charging, entertainment and Apps. It is required in cars with SA 6NS that use only a digital audio signal. The iPhone 5™ does not support video function on the plug side, therefore it is not possible to play back video in the car.

5 Series LCI

7. Entertainment and Communication

The video and plug-in functions are components of the optional equipment BMW Apps (option 6NR) and should be integrated in the Enhanced USB and Bluetooth plus Smartphone Integration (option 6 NS). However, these were cancelled with the introduction of the iPhone5[®] due to the removal of analog video support.

The following new variants are planned:

- "Basic" snap-in adapter for iPhone 5 (84 21 2 351 307)
- "Connect" snap-in adapter for iPhone 5, with a fan (84 21 2 351 308)
- "Music/Media" snap-in adapter for iPhone 5, with a fan (84 21 2 351 309)
- Snap-in adapter for Samsung smartphones
- Generic snap-in adapter for Android smartphones

5 Series LCI

8. Displays, Indicators and Controls

8.1. ID transmitter

8.1.1. Programming third and fourth button



Programmable Buttons on ID transmitter

Index	Explanation
1	Third button
2	Fourth button

In the BMW 5 Series LCI the customer has the option to assign different functions to the third and fourth button on the ID transmitter. These functions are vehicle-specific and may not be available in all 5 series LCI vehicles. The functions are assigned via a menu in the central information display.



5 Series LCI

8. Displays, Indicators and Controls



5 Series LCI configuration of third button in central information display

The following options are available for the third and fourth buttons depending on the vehicle and options:

Button	Function
Third button	<ul style="list-style-type: none">• Unlock tailgate• Unlock all doors and tailgate• Unlock small tailgate (F07)• Unlock all doors and small tailgate (F07)
Fourth button	<ul style="list-style-type: none">• Pathway lights• Auxiliary cooling (F10 hybrid only)• Panic mode

5 Series LCI

8. Displays, Indicators and Controls

8.1.2. Changeover of symbol for fourth button

The 5 Series LCI no longer has the silver horn symbol on the fourth button, is replaced with a red horn symbol.

The red horn button if pressed will activate the pathway lights and if pressed longer than two seconds the panic mode of the alarm is activated.



ID transmitter 4th button red horn symbol

8.2. Touchpad Controller

- Controller with seven buttons with touchpad in all 5 series LCI vehicles.

The labelling of the button "CD" has been changed to "MEDIA" similar to other current BMW models.

8.2.1. Controller with touchpad



Controller with touchpad

5 Series LCI

8. Displays, Indicators and Controls

The controller introduced with the headunit CIC High with turn and press controller and seven keys is replaced in the BMW 5 Series LCI worldwide with a touchpad controller that uses a touch control panel at the top at the turn and press controller. In the touchpad control panel the customer can input location information for the navigation system or telephone numbers and contact details. In the map operation the map section for example can be moved and enlarged or reduced by finger movement. Using the touchpad control panel the mouse pointer can also be moved for the Internet function.

The touchpad controller supports nine gestures during the input. This means that it is now possible to adjust controller settings in the central information display by lateral movements on the touchpad.

The gesture input can now also be used for other functions such as the operation of the Internet. Characters entered using the word match principle are now also recognized with an input at an angle between 0° and 90°.

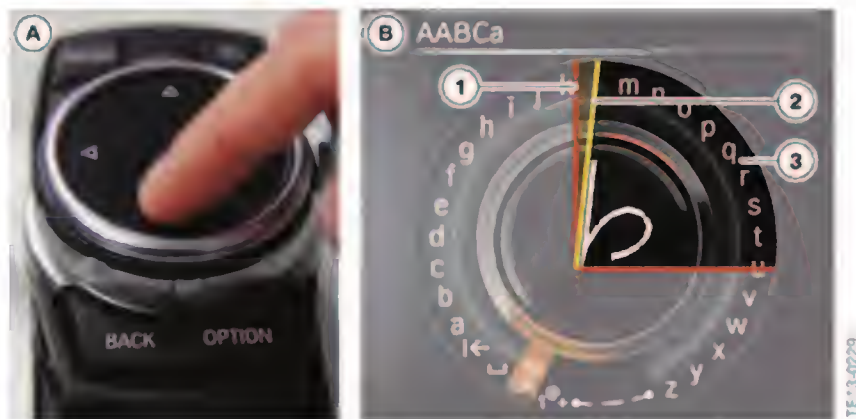

Angular range of input using wordmatch principle with touchpad

Index	Explanation
A	Input using controller with touchpad
B	Displays in Central Information Display (CID)
1	Edge of angular range for input
2	"Angle" of input
3	Angular range for input

5 Series LCI

8. Displays, Indicators and Controls

For the evaluation of inputs an additional control unit "Touch box" is used in separate country versions.



TE 12-0092

Touch box TBX control unit

The Touch box control unit is required for interpreting the contact sensors of the touchpad controller for the Headunit High user interface. The Touch box (TBX) is connected to the controller and Headunit High via the K-CAN2.



TE 13-0231

Signal path, controller with touchpad

5 Series LCI

8. Displays, Indicators and Controls

Index	Explanation
1	Central Information Display (CID)
2	Headunit High
3	Controller with touchpad
4	Touchbox (TBX)

8.3. Instrument cluster

The basic version of the instrument cluster with 4 analog round instruments is still used as standard equipment in the F10 LCI. The basic instrument cluster contains a TFT display with a resolution of 640 x 160 pixels among the instrument dials. Its diagonal screen size is 5.7". The round instruments are always enclosed by a closed ring.



5 series LCI Basic instrument cluster

Index	Explanation
1	TFT display
B	Closed instrument rings

The instrument cluster with extended contents (option 6WA) is the standard cluster in the F10H and F07 it is offered as optional equipment in the F10. It's equipped with 4 analog round instruments and a 9.2" TFT display. The display has a resolution of 960 x 160 pixels and is integrated in the lower area of the cluster.

5 Series LCI

8. Displays, Indicators and Controls



Instrument cluster with extended scopes option 6WA

8.4. CID power display in SPORT mode

In the BMW 5 Series LCI additional displays in SPORT mode are available. The displays can be called up in the CID.

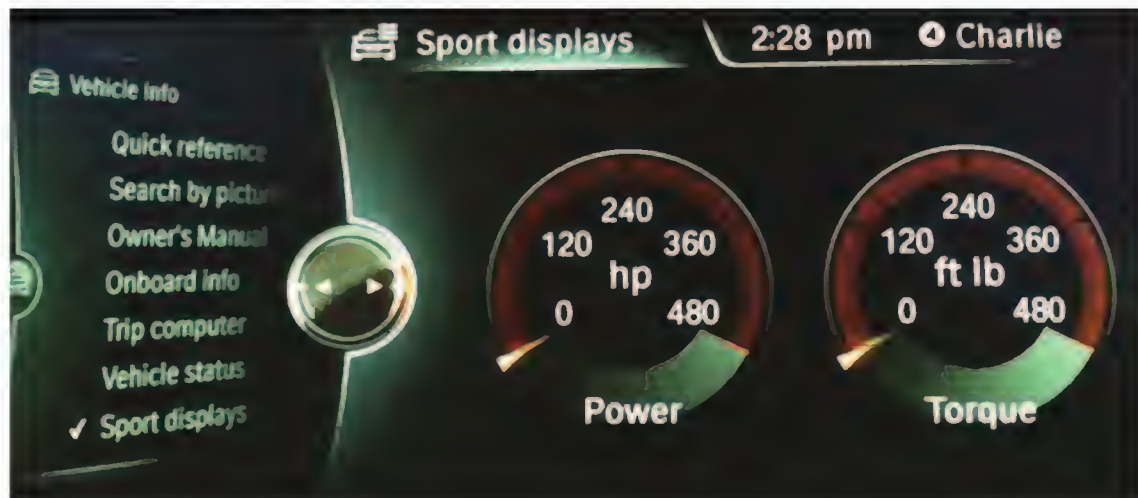

5 series LCI SPORT mode displays in the CID

5 Series LCI

8. Displays, Indicators and Controls

8.5. Driver assistance system operating facility

The individual assist systems can be activated or deactivated via the assist systems operating facility which is located next to the steering wheel in the dashboard.



BMW 5 Series LCI Driver assistance system operating facility

Index	Explanation
1	Lane change warning
2	Intelligent Safety (collision warning with braking function and pedestrian warning)
3	Lane departure warning
4	Night Vision with person detection
5	Head-Up Display

The new Intelligent Safety button replaces the previous button for the collision warning with braking function. Using the Intelligent Safety button the following front protection functions of the collision warning, collision warning with braking function and BMW Night Vision can be activated and deactivated depending on the equipment in the vehicle.

- Collision warning (camera-based collision warning and collision warning with braking function)
- Pedestrian warning (pedestrian warning with city braking function and BMW Night Vision)

If only one function is available in the vehicle, the function is switched on or off each time the button is pressed and the LED above the button is turned on or off respectively. If both functions are installed in the vehicle, a menu appears in the CID when the button is pressed in which the functions can be individually switched on or off. The LED above the button illuminates as soon as at least one of the functions is switched on. The front protection functions are automatically switched on each time the engine is started via the START-STOP button. In the case of the lane change warning and the lane departure warning as before the last setting is always retained even after an engine start.

From the information pages on Intelligent Safety you can also get to the menus for setting and adjusting the warning time of the collision warning.

5 Series LCI

8. Displays, Indicators and Controls



BMW 5 Series LCI Displays on the central information display

8.6. IHKA operating facility



IHKA operating facility in vehicles with automatic air conditioning

The operating facility IHKA in vehicles with automatic air conditioning along with 4-zone control, has been adapted in the BMW 5 Series LCI. The IHKA can be switched off by pressing and holding the button "OFF/Reduce amount of air". In addition, seven different air distributions are now available on the driver's side and six on the passenger's side.

The labelling on the button "ALL" was changed to "SYNC". By pressing the "SYNC" button the settings of the driver's side are transferred to the passenger's side and are also transferred to the rear passenger compartment.

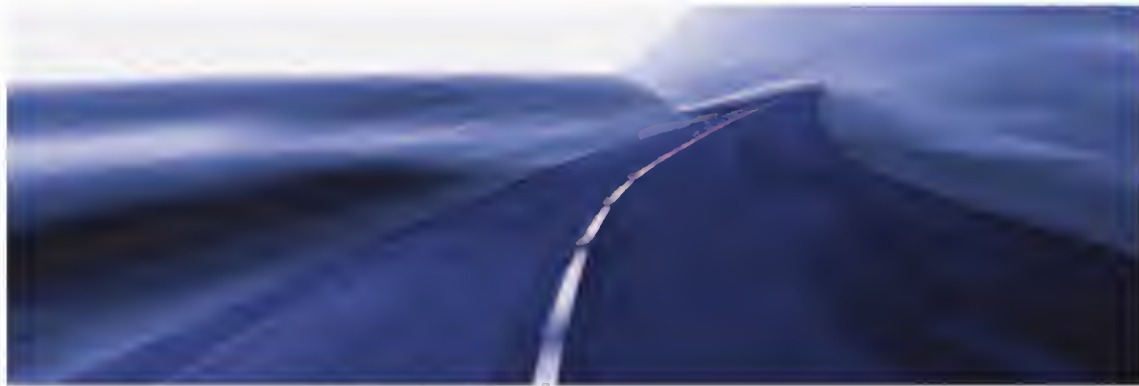

Bayerische Motorenwerke Aktiengesellschaft
Qualifizierung und Training
Röntgenstraße 7
85716 Unterschleißheim, Germany